

Introduction to Christopher Alexander: Design Patterns & Pattern Languages, Creative Process & Design Ethics.

December 8, 2016

Helmut Leitner, guest of the “Fresh Takes” seminar
Filmakademie Baden-Württemberg, Ludwigsburg

Alexander's Four Paradigms (core ideas) - a four level pyramid

the primary value: aliveness/wholeness, everyone is a designer, patterns as cultural heritage and common property, enabling for universal participation, design for life not profit

4
Ethics

a model of making as a simple stepwise generative process based on patterns, empathic perception and resonance, and learning by testing and correcting

3
Creative Cycle

pattern languages as mental tool boxes (collections of patterns) to share design expertise among all stakeholders

2
Pattern Languages

1
Design Pattern Concept

the world as network of patterns and their connections (replaces: the world as categorized objects and their properties)

Christopher Alexander

famous architect & design theorist

1936: born in Vienna

1938: the family emigrated to England

Studied at:

Cambridge: Master in Mathematics,
Bachelor in Architecture

Harvard: Dissertation in Architecture
Gold Medal for Research by the AIA

Professor at the University of Berkeley

- founded “Center for Environmental Studies”
- 200 building projects
- 14 books
- many awards
- academy member in USA and Sweden

now: professor emeritus; lives in Sussex, UK



Periods of Christopher Alexander's Works / 14 Books

1964

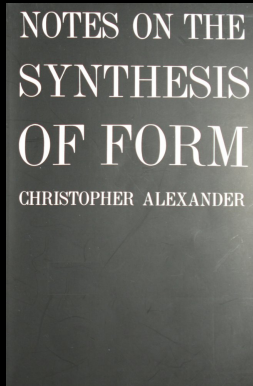

1975-1993

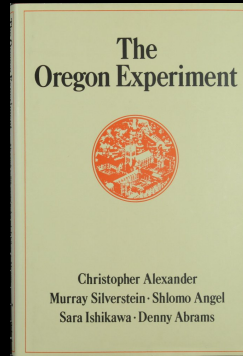
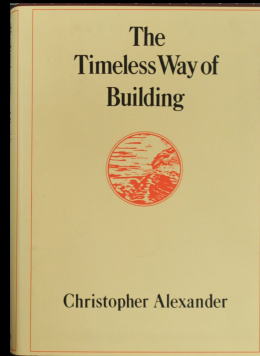
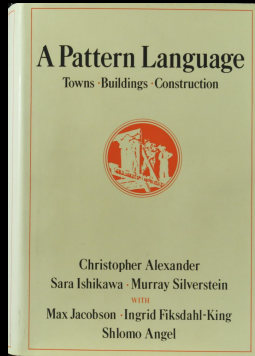

2003-2005

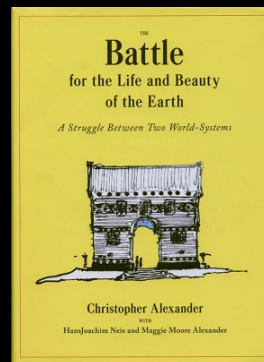
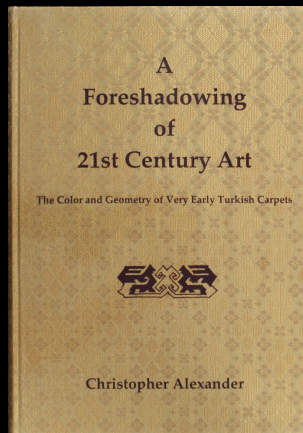
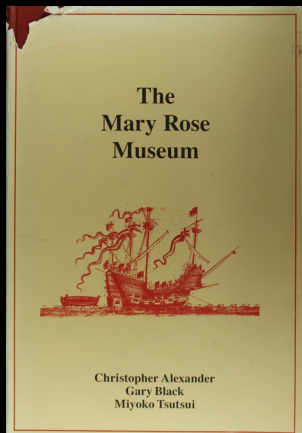
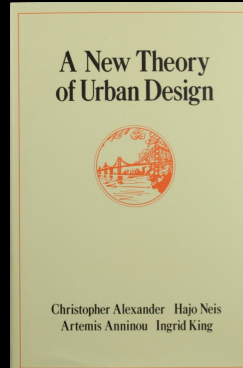
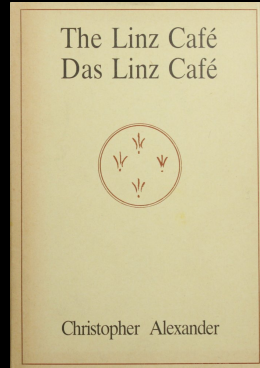
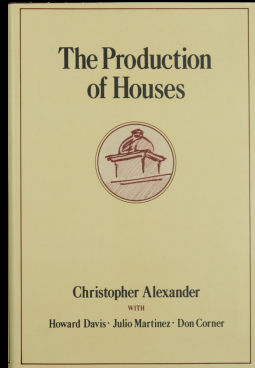
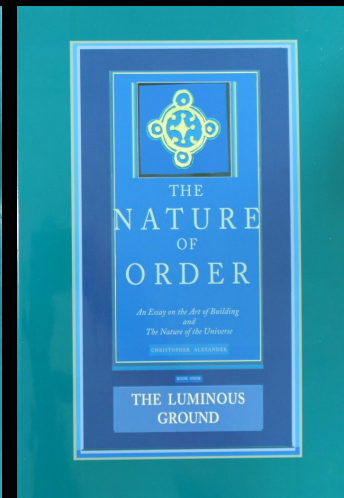
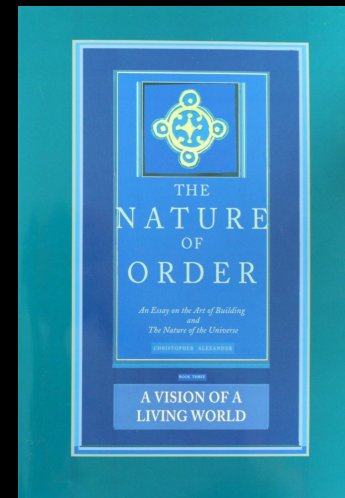
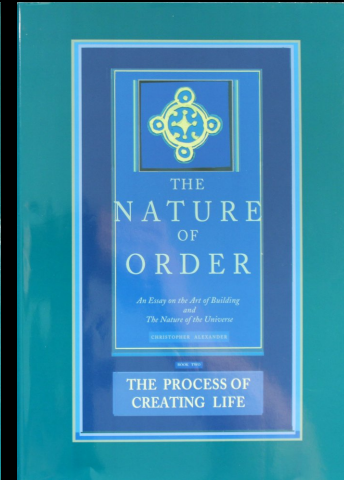
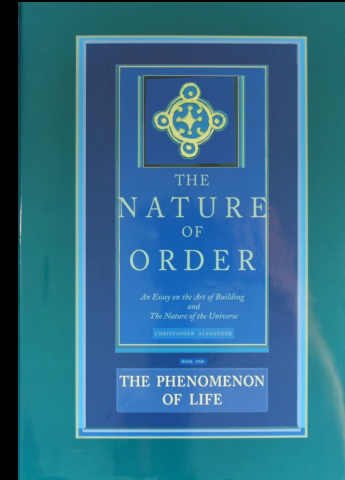

2013

learning from nature
parallel to architecture

learning from traditions / projects

form &
function,
mathematics



“Each [design] pattern describes a problem which occurs over and over again in our environment, and then describes the core of the solution to that problem, In such a way that you can use this solution a million times over, without ever doing it the same way twice.”

– Christopher Alexander, *A Pattern Language*, 1977

“A Pattern Language” ... many Pattern Languages

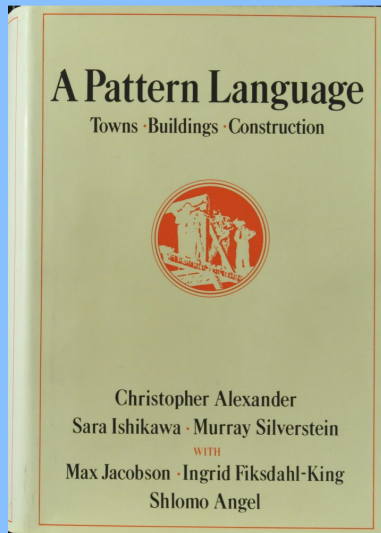

253 Patterns of
Architecture
(1977)

200+ books,
1000+ papers
80+ conferences

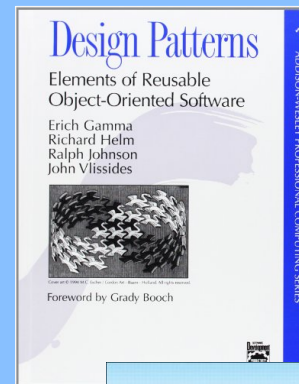

23 Patterns of
Software Architecture
(2000 Patterns in the
Software Almanach)

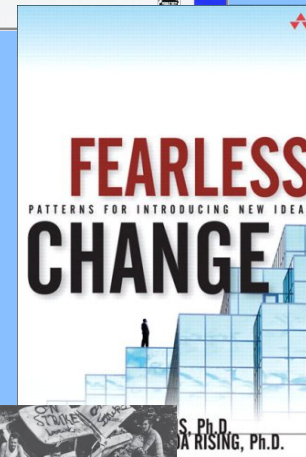

48 Patterns
of Organizational
Development

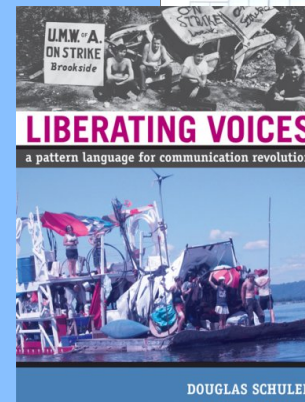

136 Patterns of
Social Activism

Pattern Language: a literary genre for nonfictional writing
to produce and disseminate experiential knowledge

PURPLSOC 2015 .. 2017

PURsuit of **P**attern **L**anguages for **SO**cietal **C**hange



Danube University Krems, Austria

3 to 5 July 2015

21 to 23 October 2017

open for theorists and practitioners of all creative domains

Mustertheorie: Einführung und Perspektiven auf den Spuren von Christopher Alexander. (2007, 2016)
www.mustertheorie.de



Christopher Alexander's theories are highly relevant far beyond architecture



Pattern Theory: Introduction and Perspectives on the Tracks of Christopher Alexander (2015)
www.patterntheory.org

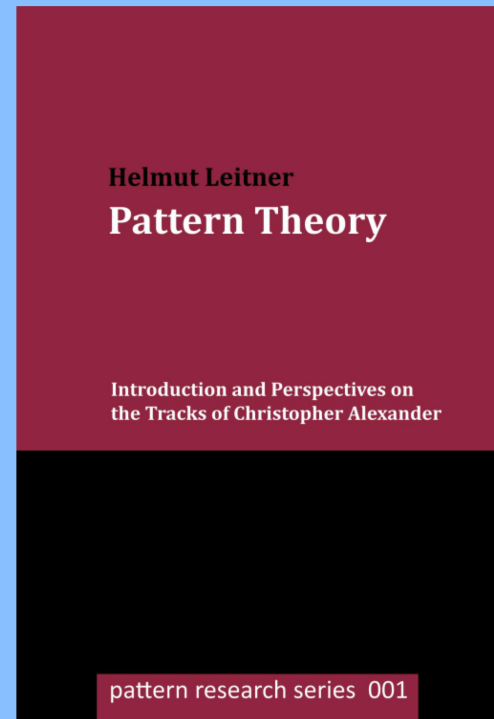

Card Stack - "64 Concepts of Pattern Theory"

"Alphabet of Design" "Christopher Alexander's World"

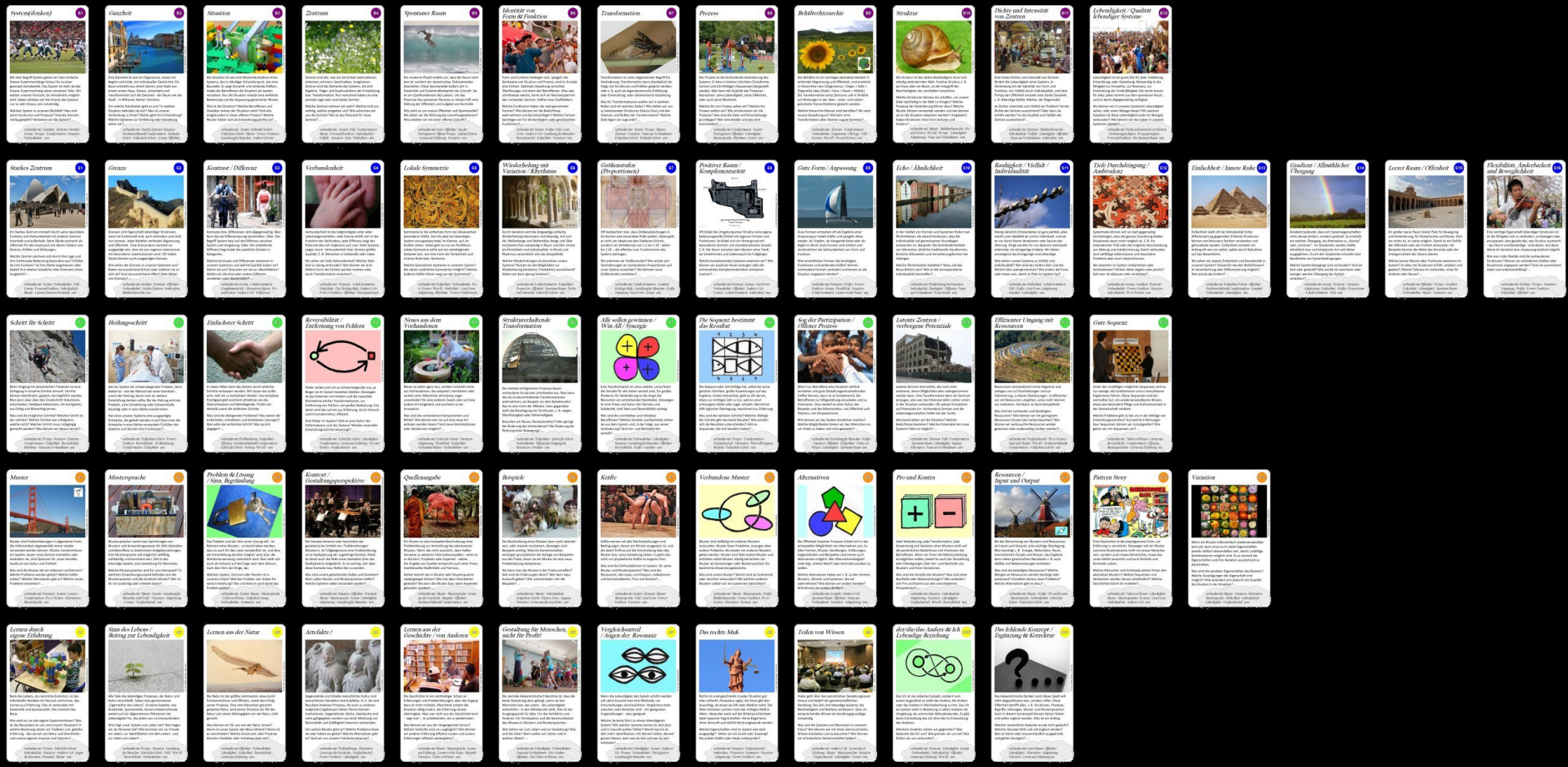

Concept Card Format

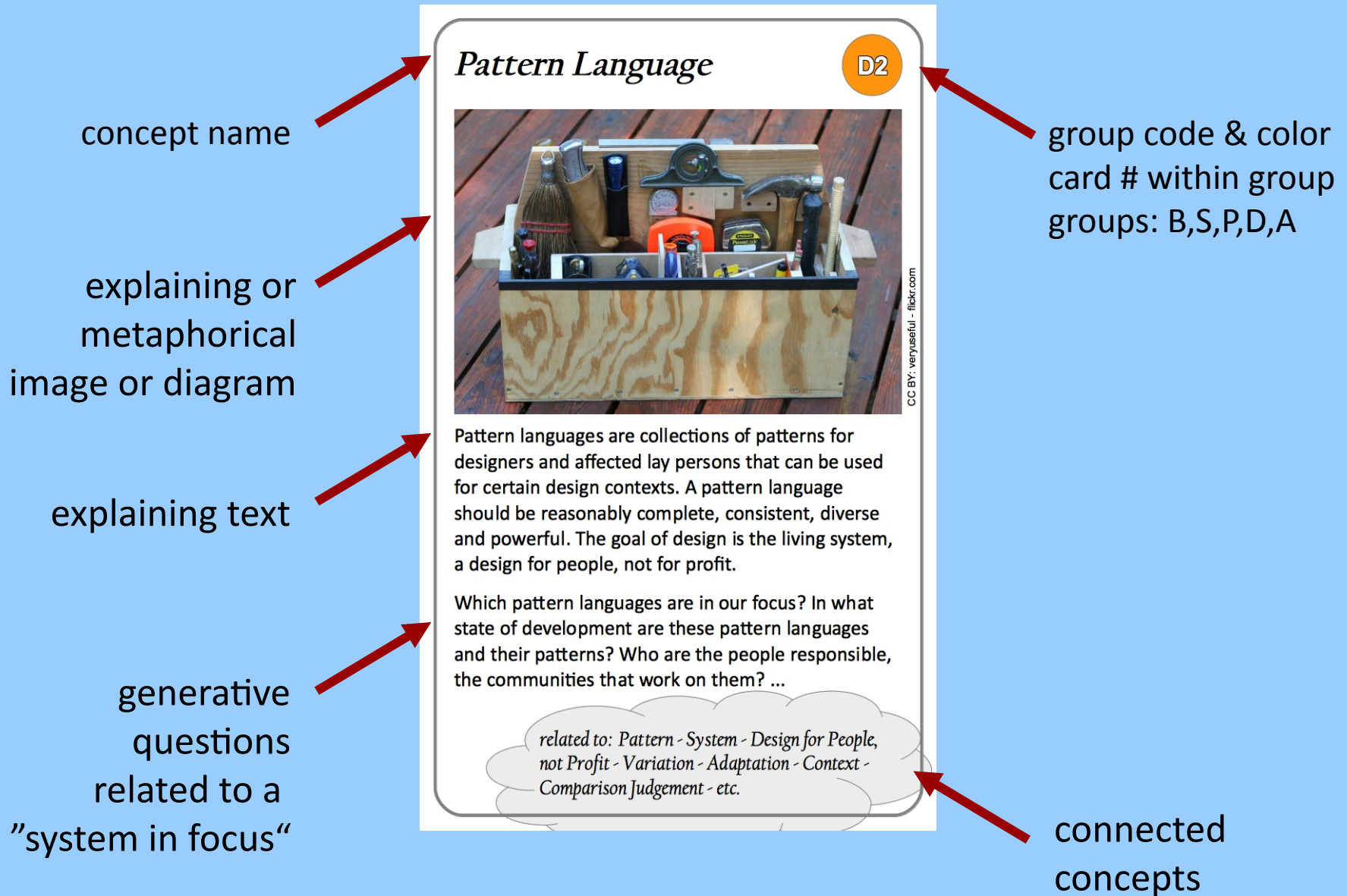

Alexander: How can we achieve Optimal Design?

Discovery 1: Not Beauty but **Lebendigkeit** is the goal
(quality of living systems = quality without a name/QWAN)
~ wholeness, aliveness, vibrancy, vividness, vitality

- ❖ the living city (architecture, landscape, village)
- ❖ the living artefact (music, story, movie, painting)
- ❖ the living organization (enterprise, project, team)
- ❖ the living community (family, relationship)
- ❖ the living self (to feel ... alive, free, unfolding)

Discovery 2: humans have an objective feeling for
this quality **Lebendigkeit** (maybe all beings have this)

Comparison Judgement – „Lebendigkeit“ (1)



Bangkok slum house

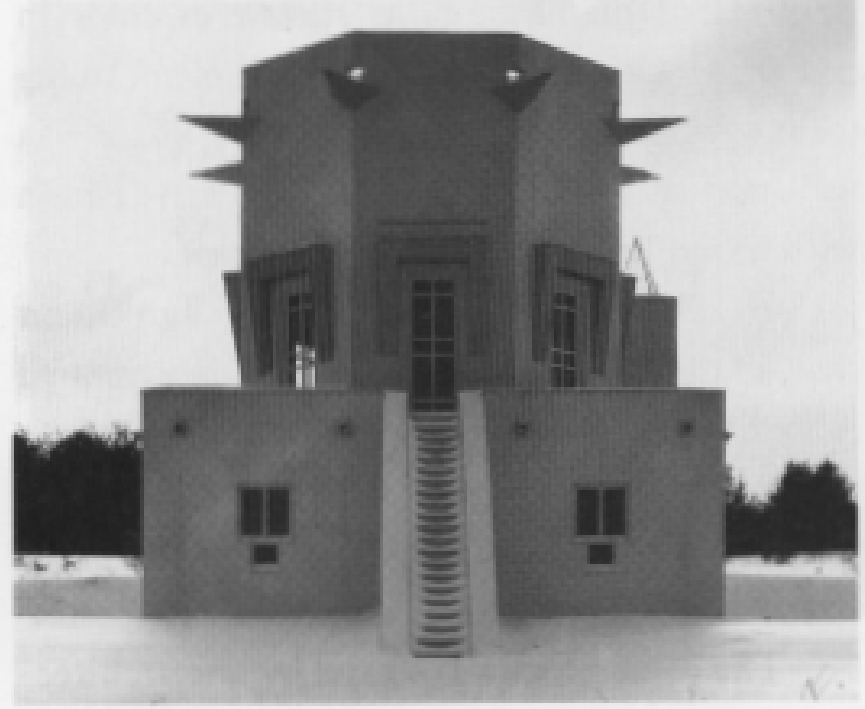

The postmodern house

Which system can you identify yourself better with?
Which system mirrors more your self, what you are and want to be?
Which system are you more in resonance with?

Comparison Judgements – „Lebendigkeit“ (2)



Which system can you identify yourself better with?
Which system mirrors more your self, what you are and want to be?
Which system are you more in resonance with?

Comparison Judgements – „Lebendigkeit“ (3)

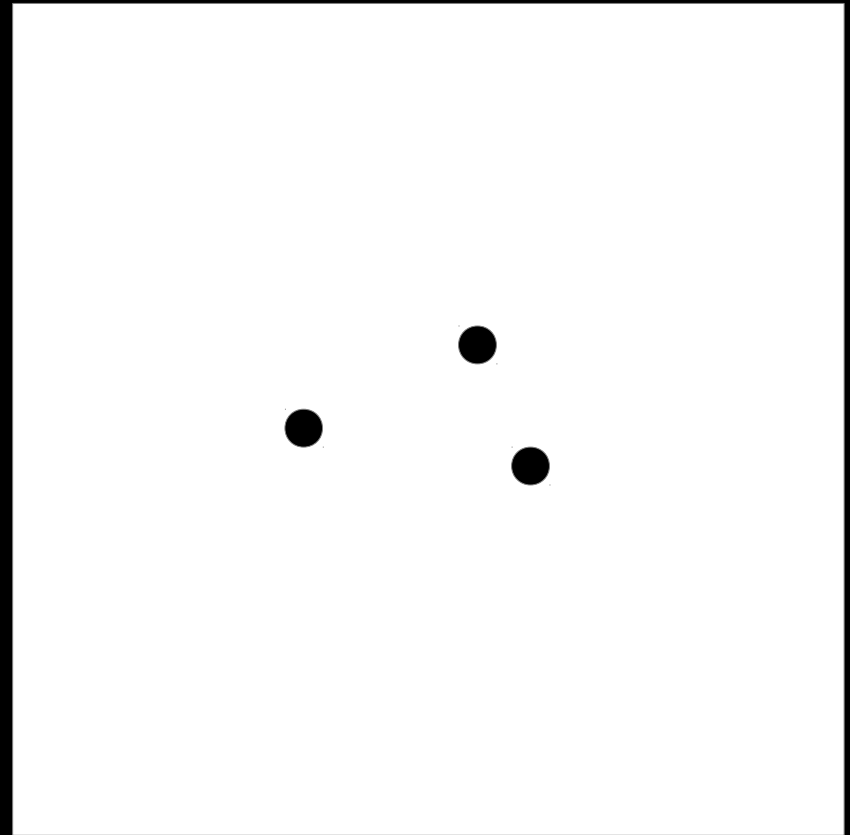
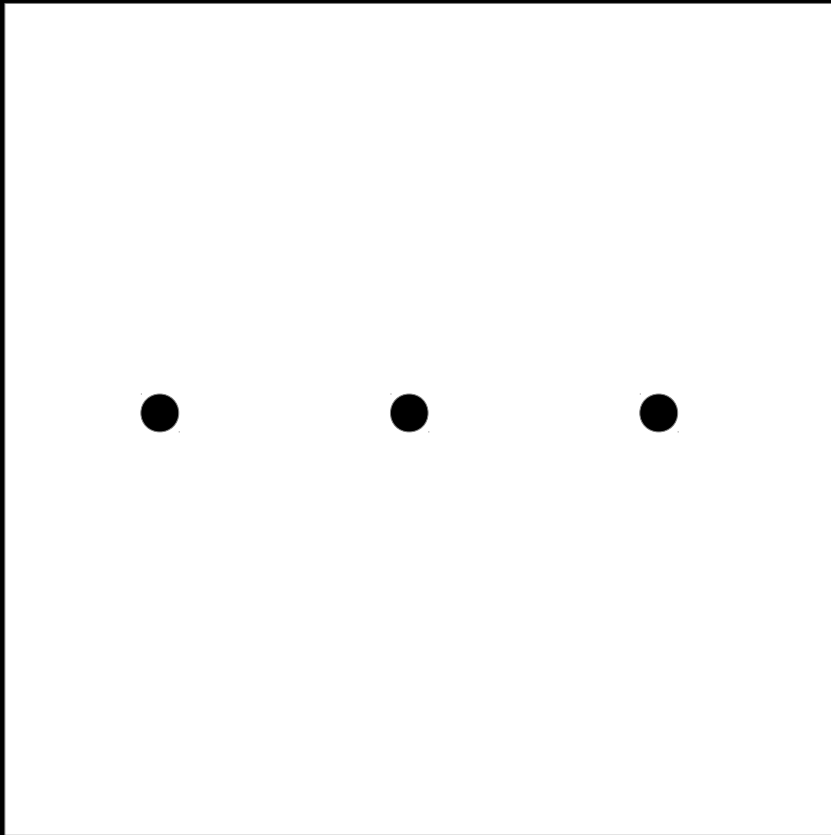

Which system can you identify yourself better with?
Which system mirrors more your self, what you are and want to be?
Which system are you more in resonance with?

Quality of Living Systems / Lebendigkeit

B12



CC BY ND: FireTom - flickr.com

Lebendigkeit (Alexander: *quality without a name*) is the goal for all unfolding, development or design. The necessary ability to judge the quality of living systems can be grown from the feelings of empathy and resonance. The fundamental impulse for life comes from spontaneous space and is omnipresent.

Where in our systems do we perceive Lebendigkeit or a lack of it? What aspects are involved with this living system quality? How can we strengthen life in our systems? ...

related to: Density and Intensity of Centres - Structure Properties - Process Prinziples - Form & Function - Spontaneous Space - etc.

Comparison Judgement / Eyes of Resonance

A7

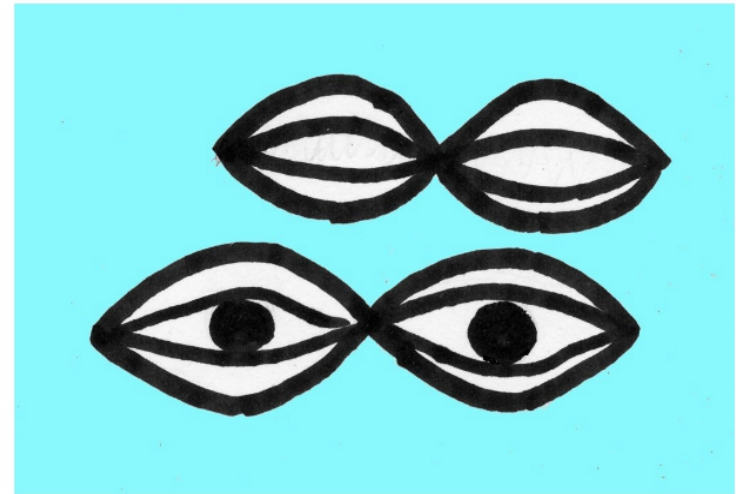

CC BY SA: Helmut Leitner

If you want to increase Lebendigkeit - the quality of living systems - you need a method to make the corresponding judgements. The side-by-side comparison of two alternatives is the easiest way to do this, if the questions are tuned to that purpose.

Which alternative resonates more with you? Which alternative is more lebendig, leads to a system that has more vitality? Which alternative corresponds more to your self, your whole being, to what you are and to what you want to be? ...

related to: Lebendigkeit - Design for People - Process - The Other & Me - Connectedness - System - Participation - etc.

Alexander: How can we create Living Systems?

- ❖ Living systems contain centers (elements) that support each other and form wholes
- ❖ Living systems show 15 structural properties
- ❖ Living systems are created by living processes which follow certain principles
- ❖ Living system get form and function by meaningful design patterns.
- ❖ Certain attitudes help the designer to create living systems.

Living Systems: Centers and Wholes

Systems as Fractal Hierarchy

(centers form wholes;
wholes contain other wholes)

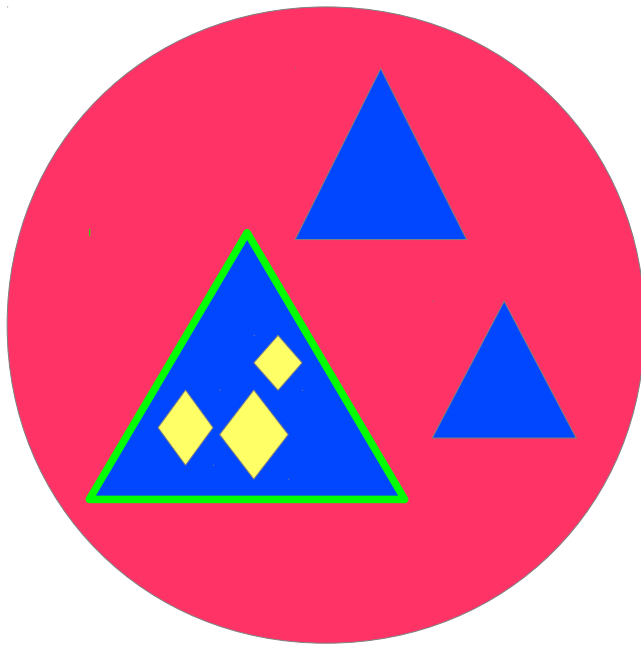

Centers are connected by Forces

(supporting each other;
3 directions of possible effects)

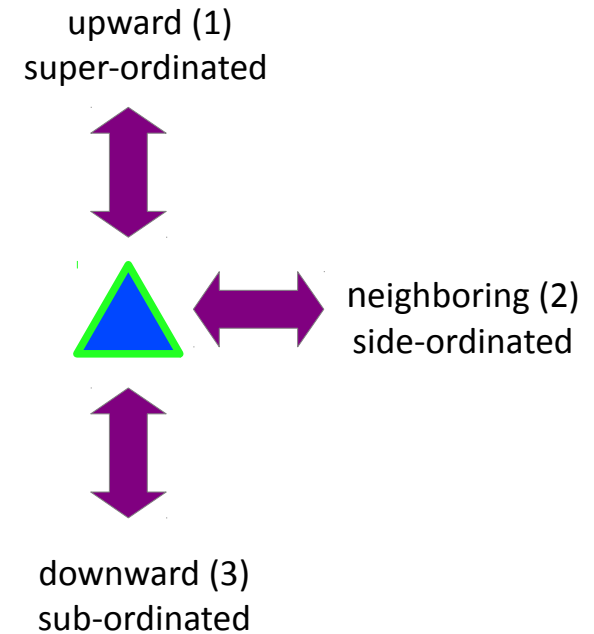

E. g. changing a house effects (1) the city (2) the neighbour houses (3) the interior & residents

Whole

B2



CC BY: MadeByMark - flickr.com

A whole is like an abstract organism, something that has a beginning and an end, and an individual history. A tree develops from a seed, a city starts with its first house. From such small starts the wholes unfold and transform - the tree and the city alike - in millions of small steps.

What are the wholes in our focus? In which situation are these wholes? How are we connected to them? Where does the development lead to? Which options of design or development do we see? ...

related to: Strong Centre - Situation - Structure
Preserving Transformation - Healing Step -
Simplest Step - Boundary - Openness - etc.

Centre

B4



CC BY: Allie_Caufield - flickr.com

The concept *centre* is used to denote things that we perceive, recognize, remember, describe, or imagine as units. Centres are the parts or elements of systems. They are the meaningful content or results of developments or transformations. Only some centres have a central position or - this is more - are *Strong Centres*.

Which centres do we perceive? Which centres are important, which slip our attention? What changes do we wish for in the existing centres? Where is the potential for new centres? ...

related to: System - Field - Transformation -
Pattern - Form & Function - Individuality /
Variety - Situation - Echo / Similarity - etc.

Forces

D7



CC BY: davidgeleadman - flickr.com

The concept *forces* contains all conditions and relations that influence a pattern and that are therefore important for deciding upon its use and its adaptation. This includes much more than just physical forces.

What are the forces that are important for our systems, their patterns and pattern languages? What are the resources, the inputs and outputs, the pros and cons, the indications and contraindications? ...

related to: System - Centre - Pattern - Pattern
Language - Field - Good Form - Form & Function
- Variation - etc.

Connectedness

S4



CC BY SA: nojhan - flickr.com

Connectedness is the most profound of all properties of living structures. Every boundary must fill the function of connection, every difference points to the potential for complementing. Many systems show their quality by the connectedness of their centres. e. g. humans in love or solidarity.

Where do we see deep connectedness? Which parts have little connection and need more? How can we reach more connectedness by transformation? How can we make this be felt? ...

related to: Contrast - The Right Measure - Local Symmetry - Participation - The Other & Me - Simplicity - Form & Function - Openness - etc.

Container Hierarchy

B9



CC BY: Roberto Verzo - flickr.com

The container is an important abstract model. It implements a protective boundary together with openness and appears in hierarchies like: (organism > organ > cell > organelle) or (city > house > room > furniture). Transformations of centres should always be judged with respect to the effects on the overall field of centres, i. e. the super-, side- and sub-ordinated levels of the container hierarchy.

Which levels of the container hierarchy are affected? Where is the leverage point of our design? How can the transformation help all levels? ...

related to: Centre - Transformation - Whole - Field - Connectedness - Context - All Win/ Synergy - Pro and Con - etc.

15 Properties of Living Structures

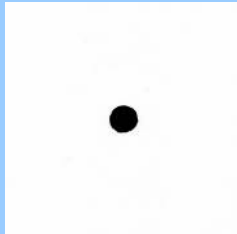

Strong Centre

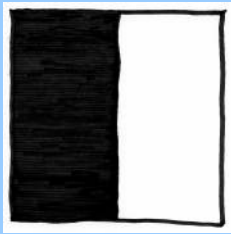

Contrast
Difference

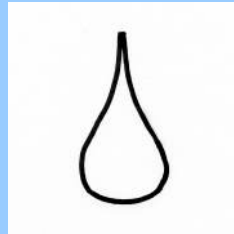

Good Form
Adaptation



Echo
Similarity



Roughness
Individuality



Boundary

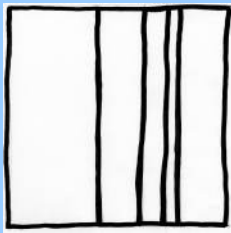

Levels of Scale
Proportion

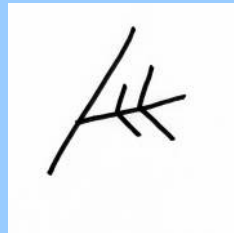

Local Symmetry



Alternating
Repetition

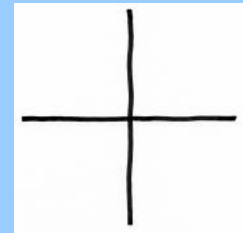

Simplicity
Inner Calm

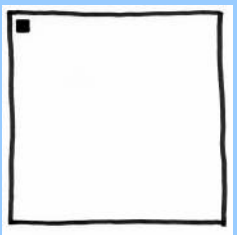

Void
Open Space

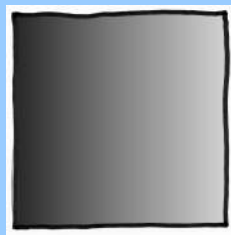

Gradient



Positive Space
Complementarity

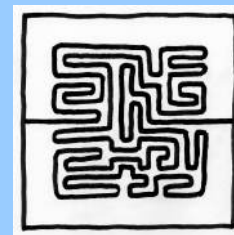

Deep Interlock
Ambiguity



Non-Separateness
Connectedness

Strong Centre

S1



CC BY: Tim Sheerman-Chase - flickr.com

A strong centre grows from its special functions and its connectedness with other centres, both outside and inside. Its strength appears e. g. as openness and continuous exchange with the field of centres and the relationships of forces.

Which centres are emphasized by their functional meaning and their central position? Do they fill their function? Is their strength in harmony with the whole or does their relative weakness or dominance ask for corrections or compensations? ...

related to: System - Connectedness - Field - Boundary - Form & Function - Individuality - Pattern - Latent Centre - etc.

Boundary

S2



CC BY: Keith Roper - flickr.com

Boundaries are inherent to living structures if they are functional, if they connect as well as they separate and protect. Each container implements both closedness and openness. A boundary can become so spacious, that it forms a separate living space with special opportunities. In many cases strong centres also have pronounced boundaries.

What quality do the boundaries of our systems have? Do they offer enough protection or do they isolate? Are the boundaries sufficiently open? Or do we need additional boundaries? ...

related to: Structure - Contrast - Openness - Connectedness - Strong Centre - Ambivalence - Container Hierarchie - etc.

Roughness / Individuality / Diversity

S11



CC BY SA: tillwe - flickr.com

When something grows naturally it is rarely perfect. It deviates from ideals and becomes individual by small deviations, e. g. small variations in properties or traces of use or age. We can recognize individual things as unique. We primarily prefer and love those things and persons that feel unique and vivid.

How do our systems show diversity and individuality? How is the being-similar and being-different appreciated? How different may somebody or something be to still have a place in our system? ...

related to: Similarity - Local Symmetry - Field - Forces - Good Form / Adaptation - Whole - Quality of Living Systems / Lebendigkeit - etc.

Principles of Living Processes

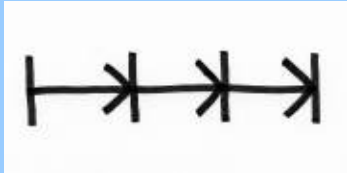

Step-by-Step

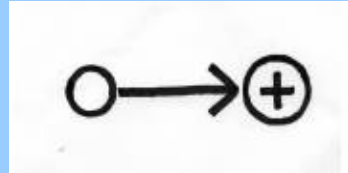

Direct Improvement



Reversibility
(Quick Error Undo)

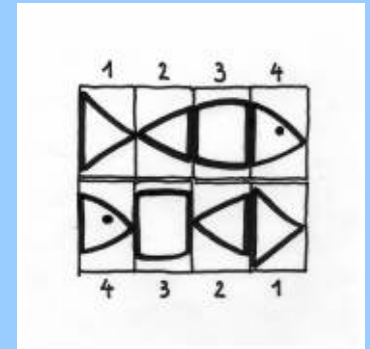

Precious Sequence
of Steps

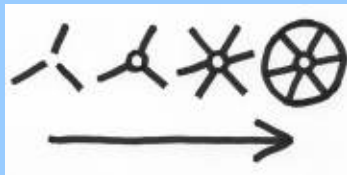

Healing Step

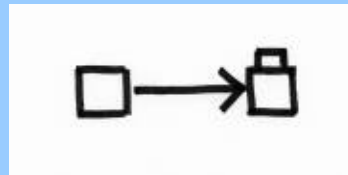

Structure Preserving
Transformation

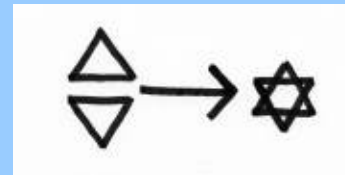

New things emerge
from the Known

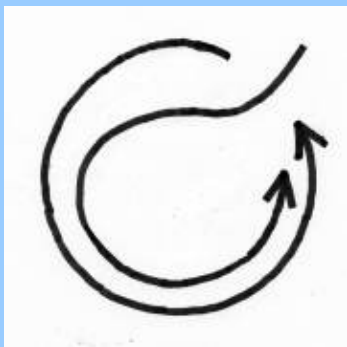

Open Process
(Pull of Participation)

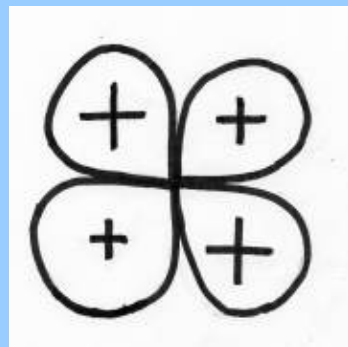

Win-Win for All
(No Losers)

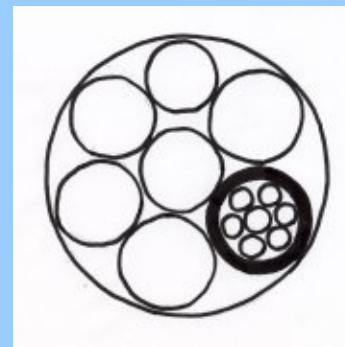

Holistic System View
(Container Hierarchy)

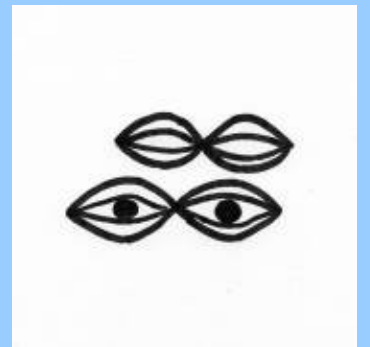

Resonance
Lebendigkeit / QUAN

Step by Step

P1



CC BY SA: moritz_schmaltz - flickr.com

Dynamic processes can be decomposed into sequences of separate steps. This makes sense because it is easier to identify, plan or work step by step than overall. You can decide pro or con a step, you can discuss it, get feedback, recognize it as success or failure, correct it, and learn from it.

What are the next steps possible? Which step should come next? Which steps were successful and which steps failed? Which steps had to be reversed? What can we learn from this? ...

related to: Process - Situation - Centre - Transformation - Simplicity - Reversibility - Rhythm - The New from the Existing - etc.

Simplest Step

P3



CC BY SA: nurmo - flickr.com

In many situations our systems can be improved by very simple steps. We ignore this because our thinking is often too complicated. The complex high-image project seems more attractive as the near and natural. Therefore: always check for the simplest step to reach your goal.

What are the most pressing problems? What would be the simplest, fastest and most direct solutions? What is the simplest step? What are the reasons not to choose it? Are these reasons valid? ...

related to: Problem & Solution - Simplicity - Efficiency - Structure Preserving Transformation - Step by Step - Healing Step - Win All - etc.

Sequences Affect Results

P8

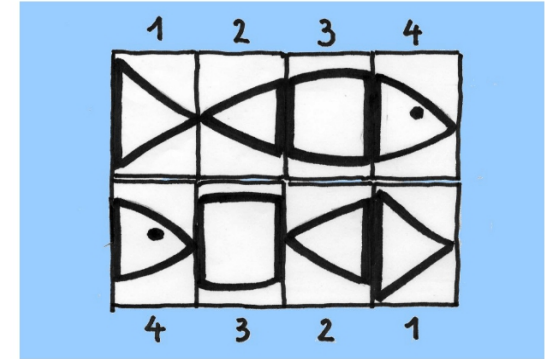

CC BY SA: Helmut Leitner

When the sequences of steps are changed the results typically change too, even if the steps are the same. Observed on a time scale, it looks like you have to find the correct point in time for some development, otherwise the step will not succeed. Logic and common sense can help, but sometimes only experience will give the successful sequences.

What are the next steps? Which sequence of these steps will give the best results? How will the results differ? Are there successful sequences from other knowledge sources available? ...

related to: Process - Transformation - Comparison Judgement - Alternative Pattern - Good Sequence - Example - Simplest Step - etc.

Win All / Synergie

P7

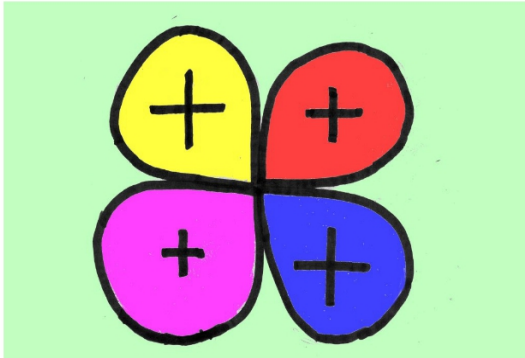

CC BY SA: Helmut Leitner

A transformation is more stable when the resulting advantages are fairly distributed. A big barrier that hinders change are people that fear possible disadvantages. Therefore a culture and praxis of fairness and solidarity, including tests and reversibility, is important.

Who are the persons affected directly and indirectly? What advantages and disadvantages do they have from the existing and the future system? Are the effects distributed fairly? ...

related to: Connectedness - Lebendigkeit - Situation - Design for People - Openness - Reversibility - Forces - Whole - etc.

Structure Preserving Transformation

P6



CC BY: jonworth-eu - flickr.com

Successful living processes often build on existing structures and improve them step by step. We can interpret this as *structure preserving transformation*, as a kind of *respect towards the existing*. Basically this also seems like a form of efficiency. The opposite is the complete removal of structures because they are faulty or superfluous.

Do we need the new and revolutionary? Or is it sufficient to adapt the existing structure, or to slightly change the organisation of a process? ...

related to: Simplicity - Step by Step - Connectedness - Efficient Use of Resources - Structure - etc.

The New from the Existing

P5



CC BY: Small Realm - flickr.com

It is very rare that something appears that is completely new. Most new things are combined, adapted or varied from existing things or parts. Sometimes a thing is even used unchanged for a new purpose or in a new way and so appears as innovation.

What potential parts, components or resources are available? How could they become effective in new ways? Can we imagine new useful combinations and variations? ...

related to: Step by Step - Adaptation - Flexibility - Simplicity - Connected Patterns - Variation - Connectedness - etc.

Pattern = Structured Experiential Knowledge

Pattern Description

Name

Problem

Solution

...

Inputs

Outputs

Connected Patterns

Alternative Patterns

Pro

Contra

...

Examples

Know-How

...

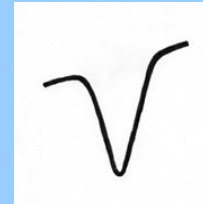

Problem



Solution

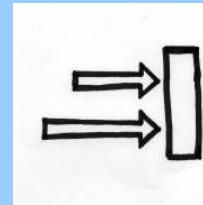

Inputs

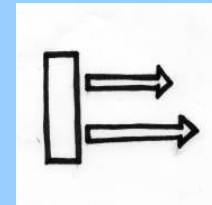

Outputs

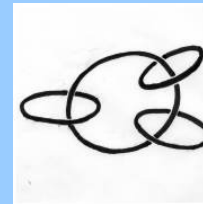

Connected P.

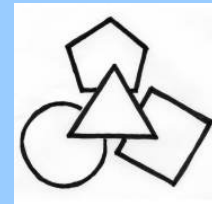

Alternative P.



Pro



Contra



Examples



Know-How

Pattern

D1



CC BY SA: Salim Virji - flickr.com

Patterns are generic problem-solution-descriptions that can be adapted to situations and reused over and over without blind repetition - like the idea *bridge* is adapted to the landscapes and our needs. Patterns transform a system. They change centres or create new centres. Patterns are alternatives for action, an expression of culture and freedom.

Which patterns do we know and recognize? Which problems are solved? What are the effective forces? What alternatives do exist? What new problem are created? ...

related to: Variation - System - Context - Transformation - Pro & Con - Alternative Pattern - Pattern Language - etc.

Connected Pattern

D8

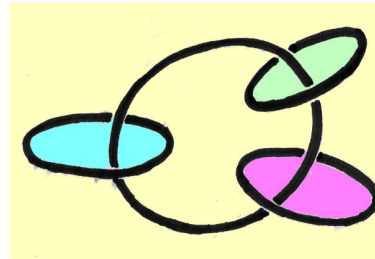

CC BY SA: Helmut Lehner

Patterns are in many ways connected to others patterns. Patterns solve problems and produce new problems - hopefully smaller - that are solved by further patterns. Patterns are fractal parts of larger patterns, and contain smaller patterns. Typically we are interested in patterns that are connected and put them in a pattern language for a certain context.

What are the patterns we focus? How are they spacially or functionally related? When we look at a pattern, which connected patterns should we also consider? ...

related to: Pattern - Pattern Language - Forces - Container Hierarchy - Form & Function - Pro & Con - Alternative Pattern - Context - etc.

Pro & Con

D10

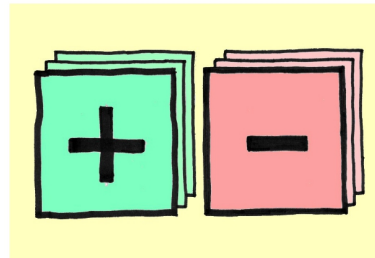

CC BY SA: Helmut Lehner

Each change, transformation, use and variation of a pattern has its effects with respect to the personal needs and interests of the affected persons. If we think that more persons should participate in design decisions, then they should have access to all the arguments, to all pros and cons regarding the patterns and their variations.

What are the advantages of a pattern? What are the disadvantages and side effects? How do the pros and cons look differently from the various perspectives? ...

related to: Situation - Individuality - Adaptation - Variation - Lebendigkeit - Comparison - Judgement - Win All - Reversibility - etc.

Alternative Pattern

D9

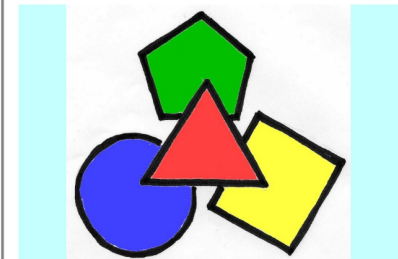

CC BY SA: Helmut Lehner - flickr.com

Creative processes are open for the possibilities of many alternatives of design. There are alternatives e. g. to each form, pattern, action, description, artefact or example. Those who suggest that there is no alternative in a given situation seem to favour a rhetoric of power and control.

What alternatives do we see to the e. g. patterns, processes, centres, systems that we perceive? How can we act differently? How can we think differently to make more alternatives available? ...

related to: Artefact - The Other & Me - Spontaneous Space - Openness - New from Existing - Variation - Adaptation - etc.

Pattern Story

D12



CC BY SA: Helmut Lehner

Stories are a very efficient way to communicate experiences and knowledge. Therefore patterns and pattern languages shouldn't be pure factual items but also pieces of literature that activate feelings, allow for identification, and show aesthetic and dramatic qualities as well.

What stories, what human fates and mental adventures are behind the abstract patterns? How does this let us understand sequences and variations? What stories can you tell? ...

related to: Knowledge Sharing - Lebendigkeit - Pattern - Pattern Language - Context - Good Form - Individuality - The Other & Me - etc.

The Commons as a Pattern Example

Name

Commons

Problem

many people can not afford their livelihoods under the existing conditions, or they fear future developments that could bring them poverty.

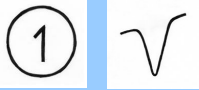

Solution

Certain necessities of life can be organized as common goods, in a way that as many people as possible have free or cheap access to these resources.



Forces

Commons need a continuous care, protection against exploitation and enclosure, both in legal (by private economy) and illegal (corruption, ...) ways. Commons need the practise of commoning.

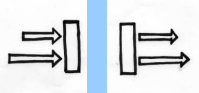

Livelihoods become cheaper. Quality of life is improved.

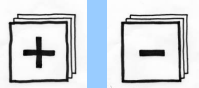

Committed persons ("Commoners") have to care for maintenance and protection (this is called the "Commoning").

Examples

A public library. An urban gardening project. A commons based central water supply of a city (e. g. Naples).



Wikipedia

exemplar of the **Commons** pattern

General Knowledge of best quality

<2003:

Encyclopedia Britannica (or Brockhaus)
20-30 volumes, expensive, 1000-2000 €

2003:

Wikipedia
free for billions of users
millions of articles (10 x)
very comprehensive, very up-to-date
maintained by some 10.000 “Wikipedians”
available in most states and most languages



Alpine Associations

exemplar of the **Commons** pattern

- 1.8 million members in 8 states
- 150+ years of development
- 100.000+ km footpaths
- 1000+ alpine huts
- 2+ million overnight stays each year

Important basis for the the economy of the Alps (tourism).
Important for the protection of the Alps



Pattern

D1



CC BY SA: Salim Virji - flickr.com

Patterns are generic problem-solution-descriptions that can be adapted to situations and reused over and over without blind repetition - like the idea *bridge* is adapted to the landscapes and our needs. Patterns transform a system. They change centres or create new centres. Patterns are alternatives for action, an expression of culture and freedom.

Which patterns do we know and recognize? Which problems are solved? What are the effective forces? What alternatives do exist? What new problem are created? ...

related to: Variation - System - Context - Transformation - Pro & Con - Alternative Pattern - Pattern Language - etc.

Pattern Language

D2



CC BY: veryuseful - flickr.com

- >
- >
- >
- >
- >

Pattern languages are collections of patterns for designers and affected lay persons that can be used for certain design contexts. A pattern language should be reasonably complete, consistent, diverse and powerful. The goal of design is the living system, a design for people, not for profit.

Which pattern languages are in our focus? In what state of development are these pattern languages and their patterns? Who are the people responsible, the communities that work on them? ...

related to: Pattern - System - Design for People, not Profit - Variation - Adaptation - Context - Comparison Judgement - etc.

Alexander's Pattern Language - array and network

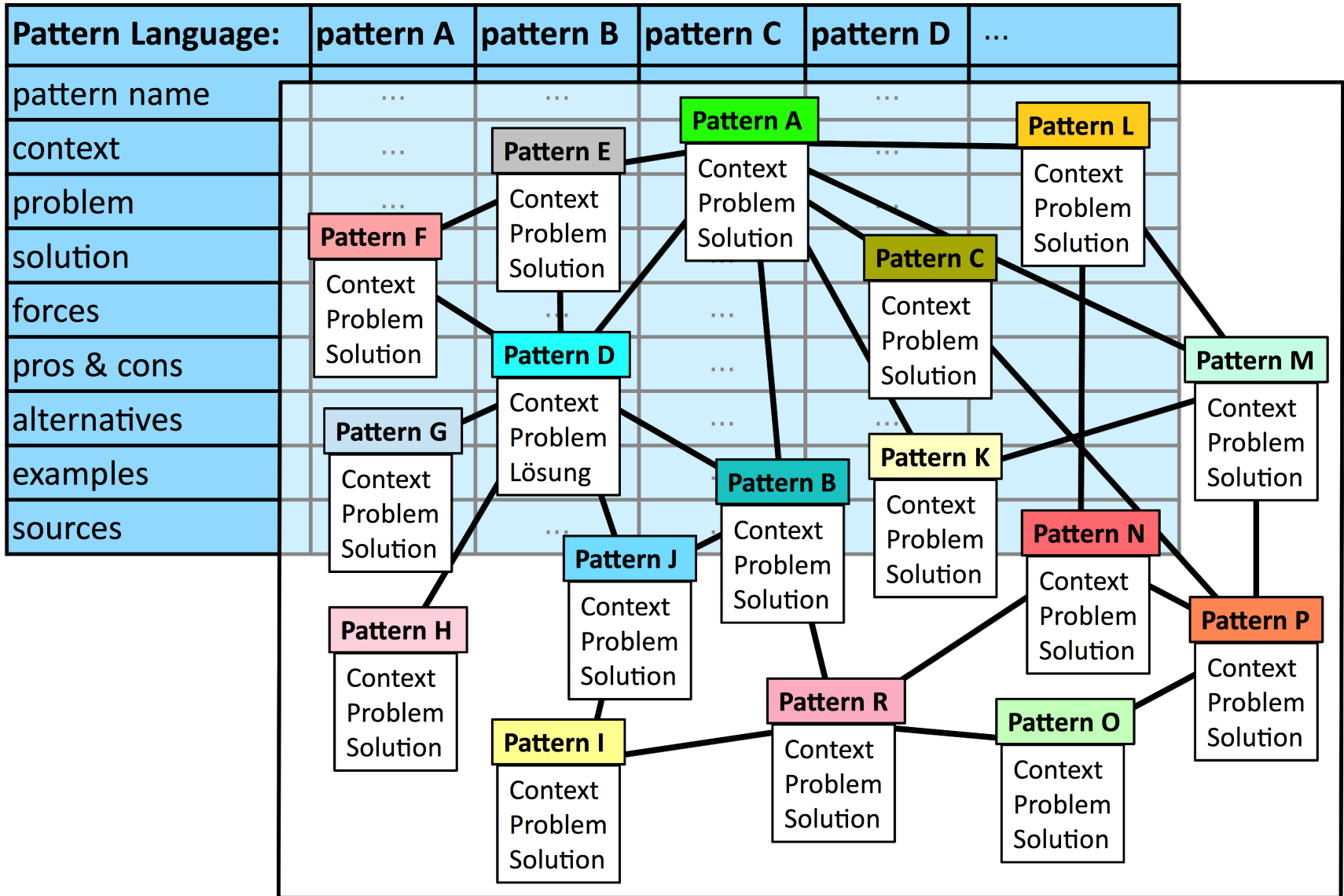

Alexander's Creative Cycle - also known as "Generative Process"

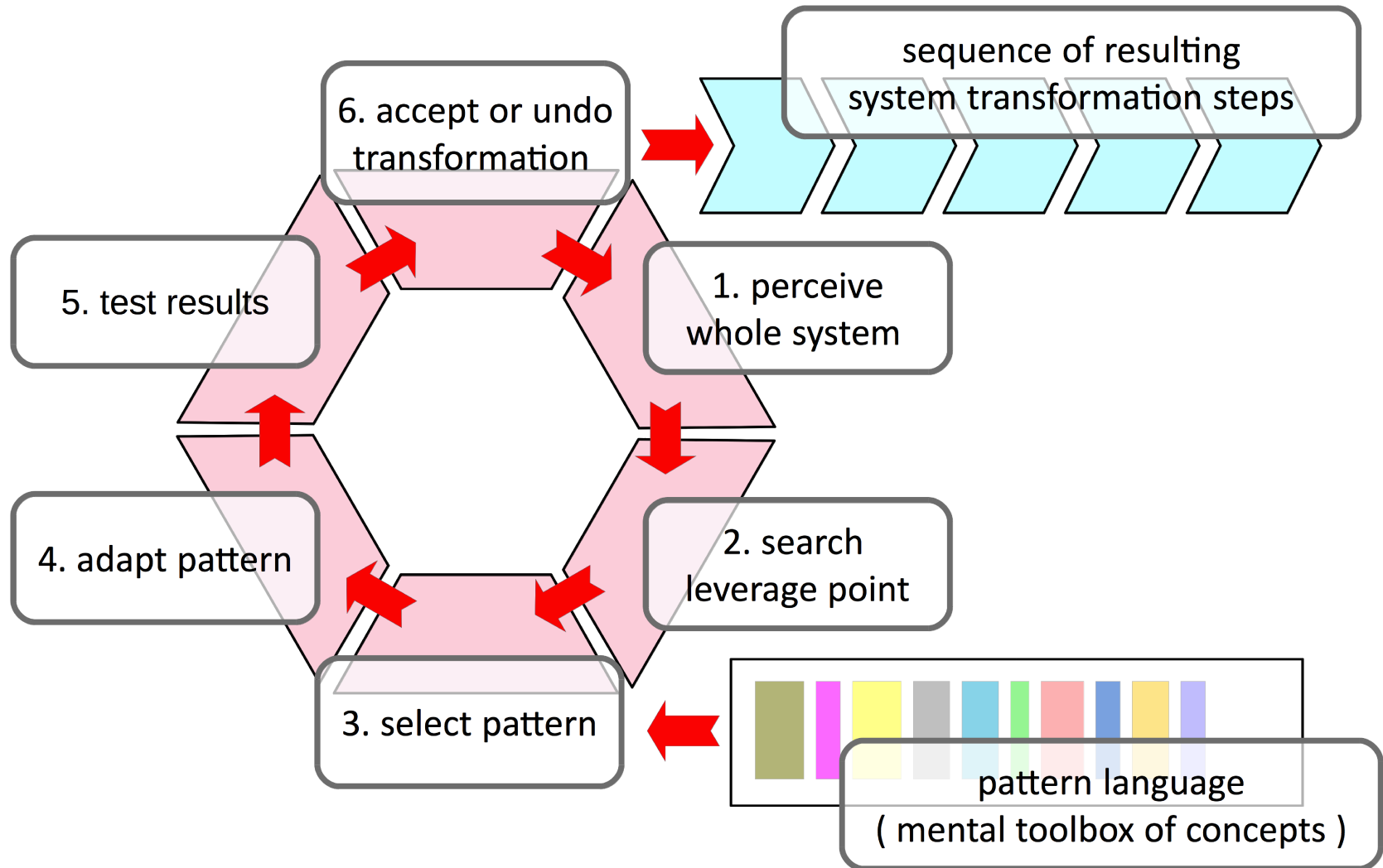

an ideal typical model for designing/creating/building (a demystification of creativity)

Mexicali project (the book "The Production of Houses") early participatory housing design in a slum of Mexico (1975)

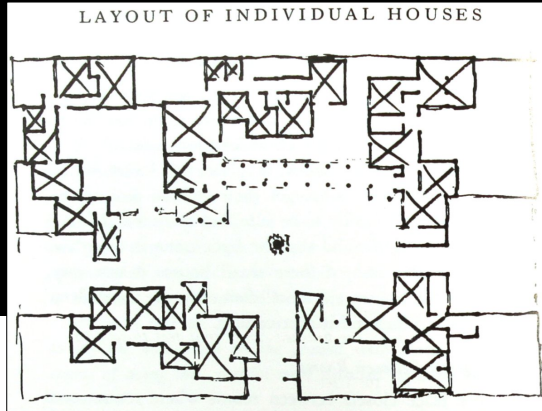

BASIC INTERLOCKING BLOCK SYSTEM

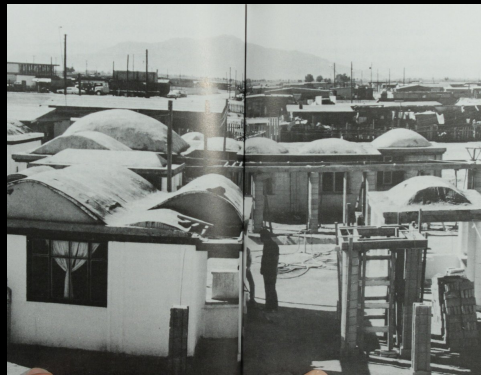
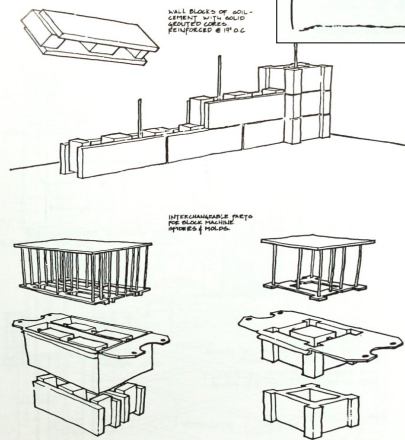

Changing the Role of the Architect

MAINSTREAM / POSTMODERN

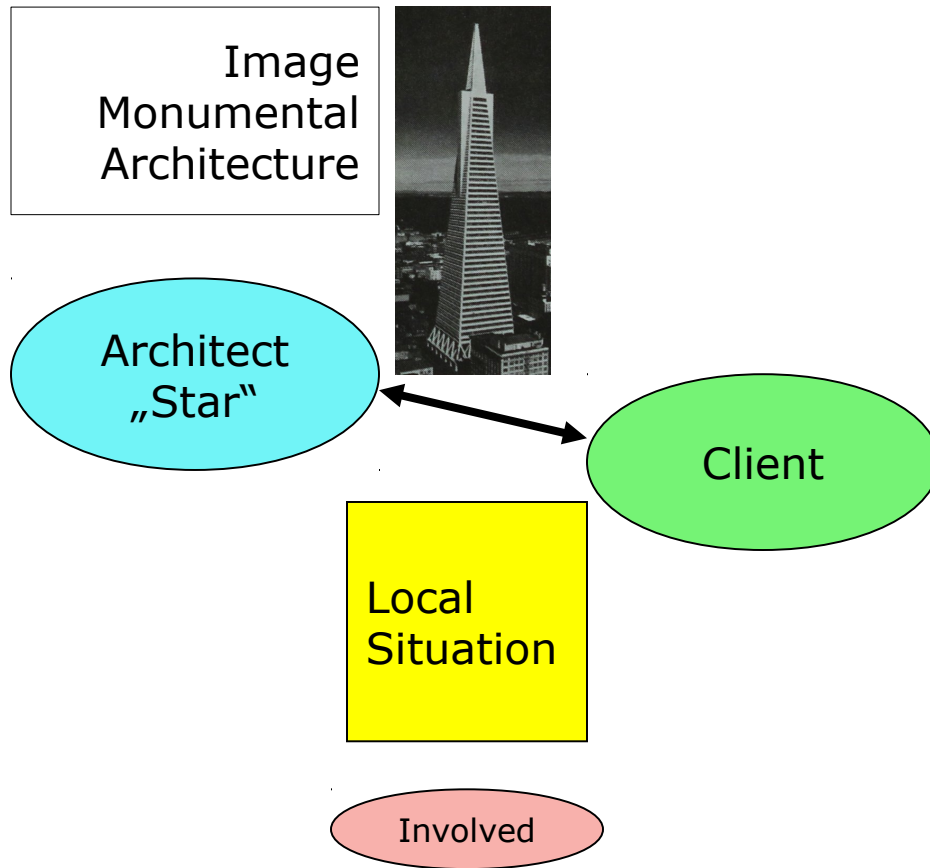

ALEXANDER / PARTICIPATORY

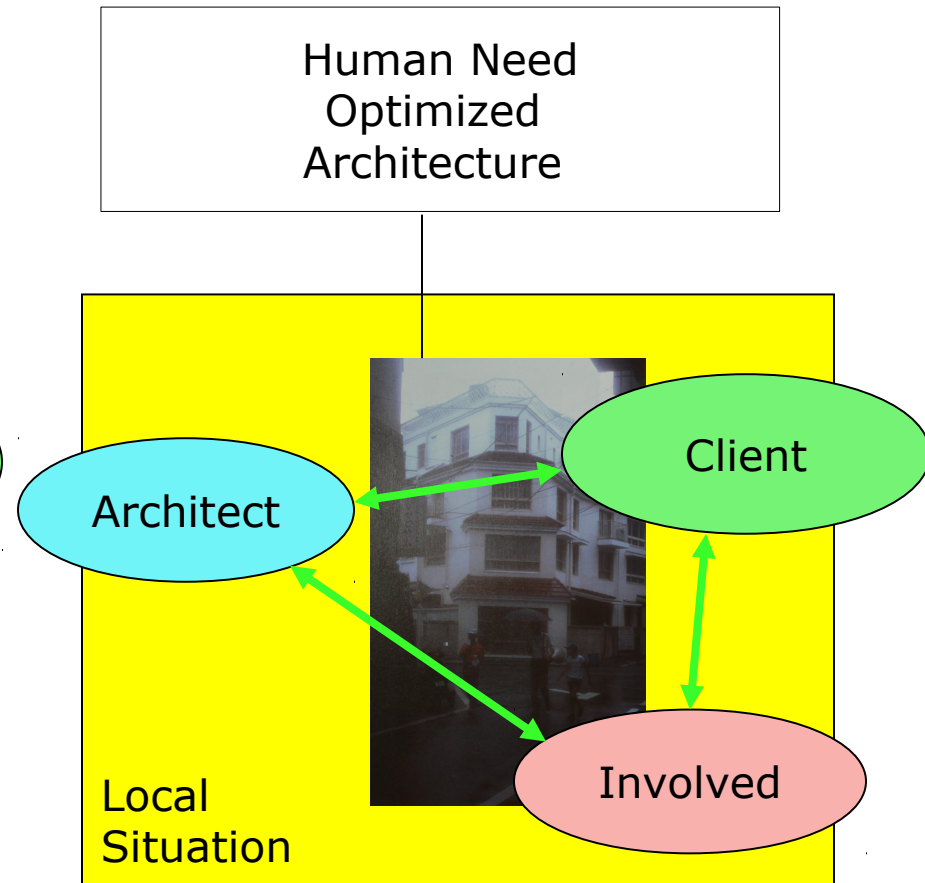

Alexandrian Ethic: a living relationships of mutual development (to care & to share)

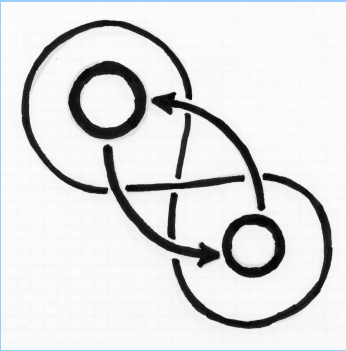

- ❖ architect-user-relationship
- ❖ designer-user-relationship
- ❖ practitioner-patient-relationship
- ❖ teacher-student-relationship
- ❖ mother-child-relationship
- ❖ coach-sportsperson-relationship
- ❖ ...
- ❖ Each Me-Other-Relationship
 - Joy in exchange & resonance
 - Joy in mutual development

The Other & Me / Living Relationship

A10

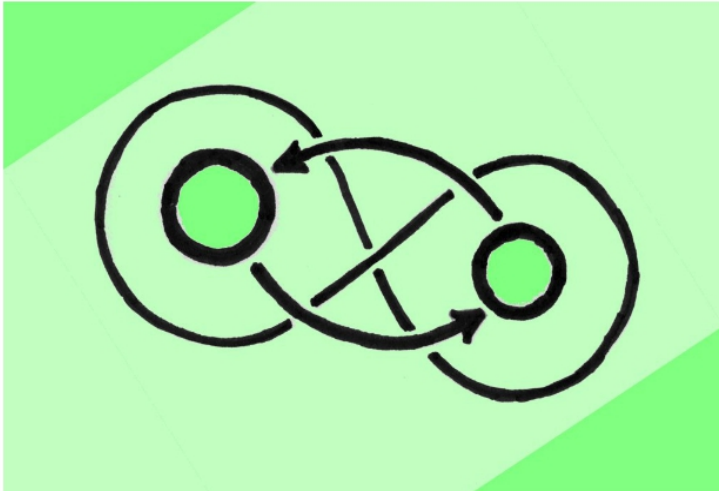

CC BY SA: Helmut Leitner - flickr.com

The me, I or self is not an isolated subject but interacts from the first moment with the other: persons, things, with the totality of the world. The self as a system is inseparable from the other as environment. Self development is connected to the development of the other. This works best in a living relationship that embodies attention, care for development, sharing of joy - the essence of love.

Which kinds of other do we face? What does this mean for us? Where do we draw our boundaries? How do we feel connected? ...

*related to: Contrast - Lebendigkeit - Boundary -
Connectedness - Individuality - Openness -
Learning from Experience - Win All - etc.*

Living Relationship

**to care,
to take the Other seriously,
to share time,
to concede value,
to respect the autonomy,
to support,
to feel the connectedness, and
to understand mutual unfolding.**

an “Operationalization“ of Love

Alexander's **Ethics** - an Ethics of Design

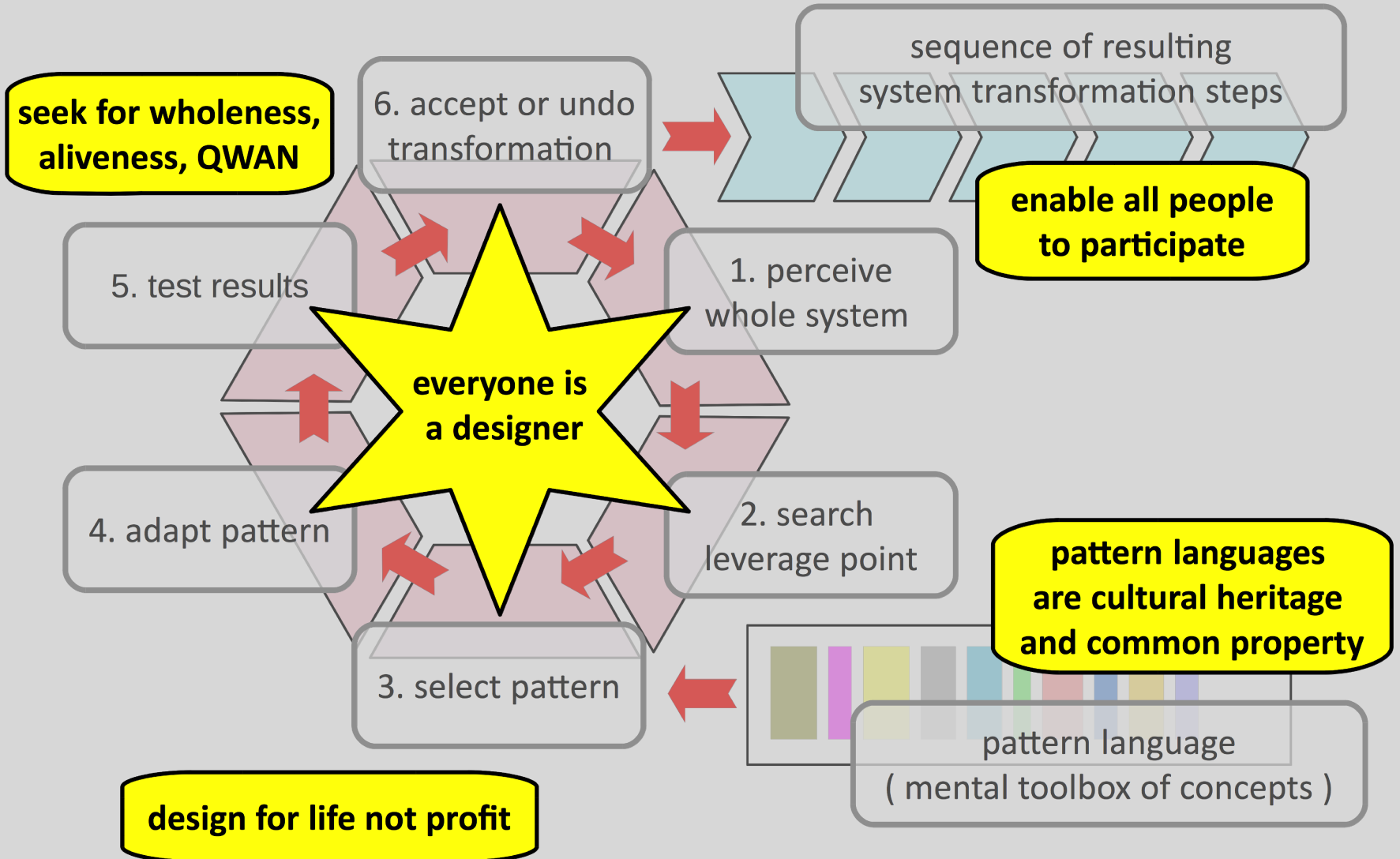

Main Effects of Pattern Language Work

Knowledge Sharing

A9



CC BY: Don Tapscott - flickr.com

Many issues are beyond the personal sphere and power and therefore need actions in community. The common goals are living systems that embody sustainability and resilience. The basis for informed decisions and successful actions must be shared knowledge of sufficient quality.

What are the systems in our focus and the affected people? How can they all communicate and collaborate to find knowledge and share it? How can the necessary communities be created? ...

related to: The Other & Me - Pattern Language - Learning from Experience - Pattern - Situation - Comparison Judgement - Lebendigkeit - System - etc.

Pull of Participation / Open Process

P9



CC BY: Yorick_R - flickr.com

If it is correct that the affected persons can understand a situation and make design decisions best, then it is fundamental to facilitate participation. This needs a culture of respect and knowledge sharing, of openness and tolerance, the attitude that it is important to empower people.

How can we make our systems more attractive? What opportunities do we offer for people to participate, to make the systems their own and to design their own life and environments? ...

related to: Design for People - Situation - Openness - Simplicity - Lebendigkeit - Forces - Spontaneous Space - Knowledge Sharing - etc.

Win All / Synergie

P7

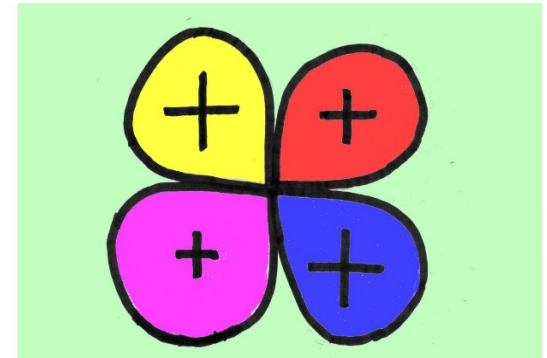

CC BY SA: Helmut Leitner

A transformation is more stable when the resulting advantages are fairly distributed. A big barrier that hinders change are people that fear possible disadvantages. Therefore a culture and praxis of fairness and solidarity, including tests and reversibility, is important.

Who are the persons affected directly and indirectly? What advantages and disadvantages do they have from the existing and the future system? Are the effects distributed fairly? ...

related to: Connectedness - Lebendigkeit - Situation - Design for People - Openness - Reversibility - Forces - Whole - etc.

Alexander's Four Paradigms (core ideas) - a four level pyramid

the primary value: aliveness/wholeness, everyone is a designer, patterns as cultural heritage and common property, enabling for universal participation, design for life not profit



a model of making as a simple stepwise generative process based on patterns, empathic perception and resonance, and learning by testing and correcting



pattern languages as mental tool boxes (collections of patterns) to share design expertise among all stakeholders



the world as network of patterns and their connections (replaces: the world as categorized objects and their properties)

END OF PRESENTATION

**THANK YOU FOR YOUR ATTENTION
I HOPE YOU ENJOYED IT**

DISCUSSION

(additional slides, in case of spare time)

Organigram of the 64 Concepts

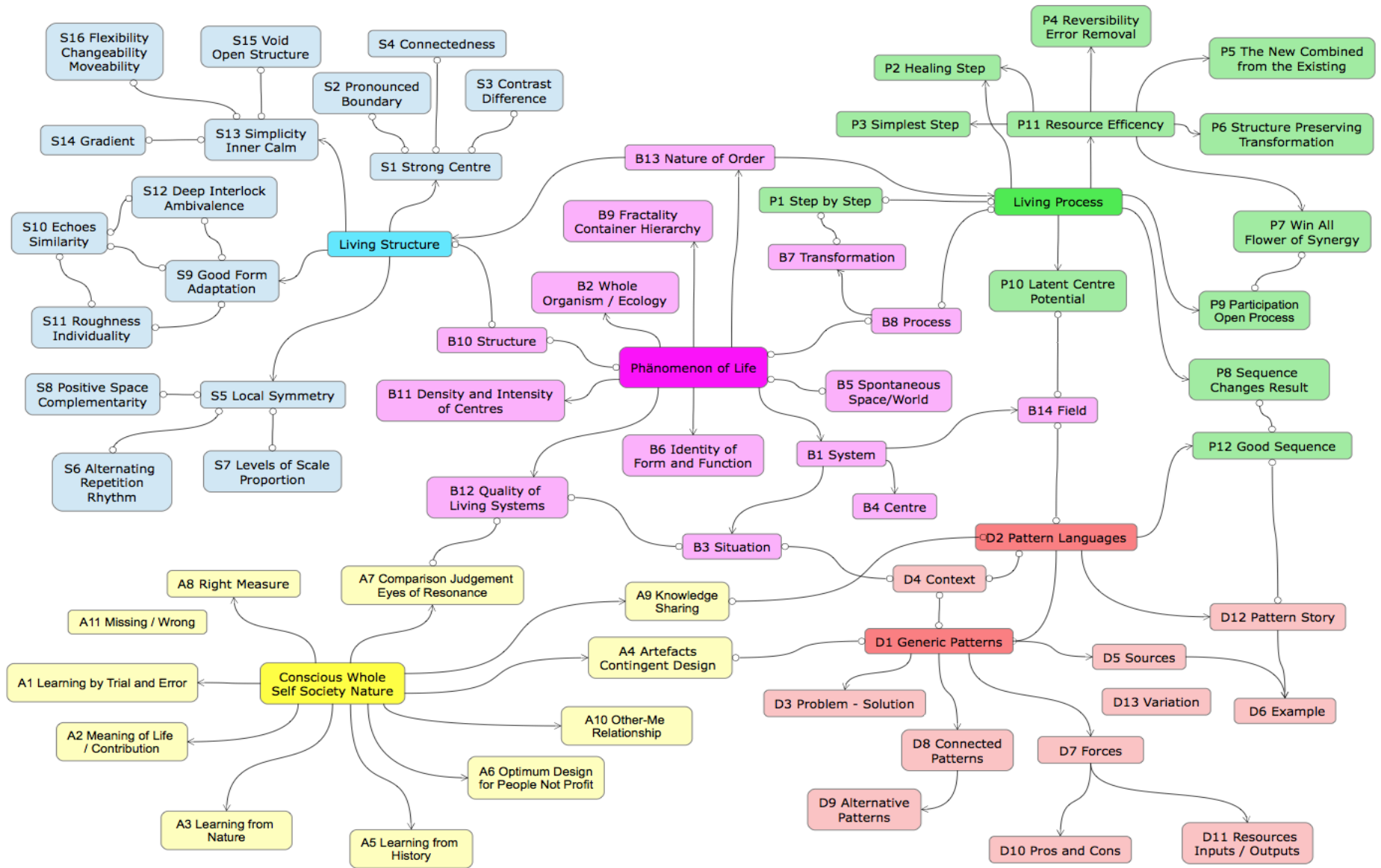

Systems Thinking

B1



CC BY-SA, ESI/Newton - flickr.com

The concept *system* is used to handle a certain complexity that is beyond simple linear relationships. The system is more than a mere configuration or sum of its parts. In looking at things we widen our horizon, we push the boundary of the system, until it becomes possible to understand, but we push only as far as necessary.

Which system is in our focus? What are its structures and processes? Is the boundary of the system correct? Do we understand the system? ...

related to: Whole - Centre - Structure - Boundary - Process - Transformation - Situation - Connectedness - etc.

Whole

B2



CC BY: Madady/Marie - flickr.com

A whole is like an abstract organism, something that has a beginning and an end, and an individual history. A tree develops from a seed, a city starts with its first house. From such small starts the wholes unfold and transform - the tree and the city alike - in millions of small steps.

What are the wholes in our focus? In which situation are these wholes? How are we connected to them? Where does the development lead to? Which options of design or development do we see? ...

related to: Strong Centre - Situation - Structure - Preserving Transformation - Healing Step - Simplest Step - Boundary - Openness - etc.

Situation

B3



CC BY: dink schaeffer - flickr.com

The situation is like a snapshot of a system that is in continuous development like a construction site. It shows dynamics and effective forces, and the people involved do understand the situation best. Only the situation allows for true evaluation and correct adaptation of generic patterns.

What is the situation? Who are the affected persons and the designers who can perceive the situation? Are they all involved in an open process? Which patterns are available for the development process? ...

related to: System - Healing Step - Simplest Step - Pattern - Form & Function - Design for People - The Other & Me - etc.

Centre

B4



CC BY: Alag, Crawford - flickr.com

The concept *centre* is used to denote things that we perceive, recognize, remember, describe, or imagine as units. Centres are the parts or elements of systems. They are the meaningful content or results of developments or transformations. Only some centres have a central position or - this is more - are *Strong Centres*.

Which centres do we perceive? Which centres are important, which slip our attention? What changes do we wish for in the existing centres? Where is the potential for new centres? ...

related to: System - Field - Transformation - Pattern - Form & Function - Individuality / Variety - Situation - Echo / Similarity - etc.

Spontaneous Space

B5



CC BY-SA, Falzone - flickr.com

Modern physics teaches an empty space that is not empty but a dynamic and fluctuating process. This spontaneity results in creativity and in a future that is not controllable. This is the fundamental precondition for the phenomenon of life. To use the potential of spontaneous space, develop an attitude of openness and stop trying to be in control.

What is the state of our openness and spontaneity? Where do we see the effects of the unforeseeable? How can we work in face of an open future? ...

related to: Void / Openness - Pull of Participation / Open Process - Latent Centre - Learning from Experience - Variation - etc.

Identity of Form & Function

B6



CC BY-SA, Mark Frasier - flickr.com

Forms and functions are interrelated, just reflect our thinking in structures and processes, and are basically identical. Optimum design drops all that is dispensable to serve the affected people best. Every whole - growing step by step - gets its form through the relation to existing centres, fields and forces according to the functions it fills.

Which functions have the perceives forms? How can we understand and design according to existing needs? Which forms can provide the functions that are needed? ...

related to: System - Forces - Field - Good Form - The Other & Me - Design for People - Resonance - Judgement - Simplicity - Variation - etc.

Transformation

B7



CC BY-SA, Diernter1983 - flickr.com

Transformation is our most abstract word for change, especially used for small scale change. Transformation can be thought physically as a result of structures and forces, or as a step of selforganized unfolding, or as a step of a goal-oriented development or design.

What kind of transformation do we want? What goals and what roles go with this? What is our position towards existing structures (*status quo*) and the chances and risks of transformation? What goals do we declare fundamental? ...

related to: System - Process - Pattern - Centre - Variation - The New from the Existing - Simplest Step - Healing Step - etc.

Process

B8



CC BY-SA, C. Bahnsen - flickr.com

The process is the continuous change of the system. It can be presented in small steps (transformations) and sequences of steps. You also can look at the quality of the process: its openness, its vitality (*Lebendigkeit*), or its mechanics.

What kind of process do we see? What kind of process do we want? How do we structure the process? What are the goals and fundamentals for our decisions? How are the decisions made and who makes the decision? ...

related to: Transformation - Participation / Openness - System - Quality of Living Systems / Lebendigkeit - Pattern - Rhythm - Learning - etc.

Container Hierarchy

B9



CC BY: Roberto Vazco - flickr.com

The container is an important abstract model. It implements a protective boundary together with openness and appears in hierarchies like: (organism > organ > cell > organelle) or (city > house > room > furniture). Transformations of centres should always be judged with respect to the effects on the overall field of centres, i. e. the super-, side- and sub-ordinated levels of the container hierarchy.

Which levels of the container hierarchy are affected? Where is the leverage point of our design? How can the transformation help all levels? ...

related to: Centre - Transformation - Whole - Field - Connectedness - Context - All Win / Synergy - Pro and Con - etc.

Structure

B10



CC BY: pallama - flickr.com

Structure is the relatively persistent in a world that is changing continuously. Good structures, e. g. a house or a tree, are the models of sustainability, of a meaningful investment.

What structures can we create to implement our goals and fill the needs sustainably? Which process brings about the necessary change? Which patterns can be used? How can the patterns be adapted to the situation? Conversely: which structures hinder, having lost their meaning and might be removed? ...

related to: Pattern - Container Hierarchy - Pro & Con - All Win - Process - Quality of Living Systems - Adaptation - New from Existing - etc.

Density and Intensity of Centres

B11



CC BY: Steve Dean - flickr.com

High densities and intensities of centres increase the quality of living systems. Connect this to principles of the identity of form and function, individuality leading to diversity, or the principle of openness and you get a strong dynamic process, as you can see e. g. in markets, living cities, or rain forests.

Is the density, intensity and diversity of centres sufficient? Or are they already a problem? Are there enough centres? Are we satisfied with the quality and diversity of the existing centres? Should new centres be created? ...

related to: Centre - Individuality / Diversity - Lebendigkeit - Openness - Container Hierarchy - The New from the Existing - Ambivalence - etc.

Quality of Living Systems / Lebendigkeit

B12



CC BY ND: Flea Tom - flickr.com

Lebendigkeit (Alexander: *quality without a name*) is the goal for all unfolding, development or design. The necessary ability to judge the quality of living systems can be grown from the feelings of empathy and resonance. The fundamental impulse for life comes from spontaneous space and is omnipresent.

Where in our systems do we perceive Lebendigkeit or a lack of it? What aspects are involved with this living system quality? How can we strengthen life in our systems? ...

related to: Density and Intensity of Centres - Structure Properties - Process Principles - Form & Function - Spontaneous Space - etc.

Strong Centre

S1



CC BY: Tim Sheerman-Chase - flickr.com

A strong centre grows from its special functions and its connectedness with other centres, both outside and inside. Its strength appears e. g. as openness and continuous exchange with the field of centres and the relationships of forces.

Which centres are emphasized by their functional meaning and their central position? Do they fill their function? Is their strength in harmony with the whole or does their relative weakness or dominance ask for corrections or compensations? ...

related to: System - Connectedness - Field - Boundary - Form & Function - Individuality - Pattern - Latent Centre - etc.

Boundary

S2



CC BY: Karin Rogner - flickr.com

Boundaries are inherent to living structures if they are functional, if they connect as well as they separate and protect. Each container implements both closedness and openness. A boundary can become so spacious, that it forms a separate living space with special opportunities. In many cases strong centres also have pronounced boundaries.

What quality do the boundaries of our systems have? Do they offer enough protection or do they isolate? Are the boundaries sufficiently open? Or do we need additional boundaries? ...

related to: Structure - Contrast - Openness - Connectedness - Strong Centre - Ambivalence - Container Hierarchy - etc.

Contrast / Difference

S3



CC BY: SA: ThisParticularGrog - flickr.com

Contrasts or differences are omnipresent. We can understand this as the result of differentiation. Or: The concept *system* is based on the difference between the system and its environment. Or: the species-forming difference is the foundation of the western categorial thinking.

What contrast and differences exist in our systems and what qualities do they have? Do they hinder? Do we need them, e. g. for identification? Do we want to bridge or strengthen one or the other contrast or difference? ...

related to: Boundary - Individuality / Diversity - Local Symmetry - Complementarity - Alternative - Pro & Con - The Other & Me - etc.

Connectedness

S4



CC BY: SA: myriam - flickr.com

Connectedness is the most profound of all properties of living structures. Every boundary must fill the function of connection, every difference points to the potential for complementing. Many systems show their quality by the connectedness of their centres. e. g. humans in love or solidarity.

Where do we see deep connectedness? Which parts have little connection and need more? How can we reach more connectedness by transformation? How can we make this be felt? ...

related to: Contrast - The Right Measure - Local Symmetry - Participation - The Other & Me - Simplicity - Form & Function - Openness - etc.

Local Symmetry

S5



CC BY-ND: murkysyrc - flickr.com

Symmetry is a simple property of structures that emerges naturally in the absence of forces. Symmetry exists with living systems primarily in the small scale, i.e. locally. Symmetry is rare in large scale. Local symmetry is not related to perfection, it should feel like something simple and relaxed, something in peace and harmony.

Where do symmetries exist in our systems?
Where could additional symmetries be possible?
What forces lead us away from symmetry? ...

related to: Simplicity - Connectedness - Win All - Pro & Con - Similarity - Form & Funktion - Good Form / Adaptation - Rhythm - etc.

Alternating Repetition / Rhythmic Variation

S6



CC BY-ND: la mila mila - flickr.com

Pure repetition is simple and boring. It becomes interesting and *lebendig* by alternating variations. Ups and downs, wave peaks and troughs, mountains and valleys appear almost inevitably in space and time, always connected to similarity and individuality. Music implements this beautifully in its measures and rhythms.

What repetitions give structure to our systems? Do we use the opportunities to repeat, imitate, produce sufficiently? Is there enough variation in this repetition? ...

related to: Local Symmetry - Simplicity - Proportion - Openness - Spontaneous Space - Density and Intensity - Step by Step - etc.

Levels of Scale / Proportions

S7

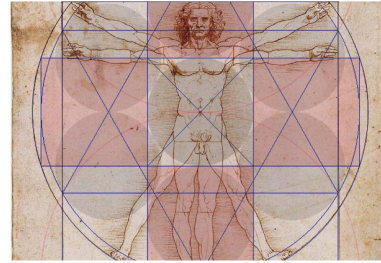

CC BY-SA: GeometerArtist - flickr.com

One can often observe that *Levels of Scale* are present in living structures. We do not know why they exist as they do. These levels do not follow ideals like the golden ratio, but proportions like 1:2 to 1:10, in rare cases up to 1:20, that contribute to the living quality of the system.

Where do we see such levels of scale? How would a change in these proportions affect our system and its quality? Where could we introduce new levels of scale? ...

related to: Local Symmetry - Gradient - The Right Measure - Design for People - Forces - Good Form / Adaptation - Boundary - etc.

Positive Space / Complementarity

S8

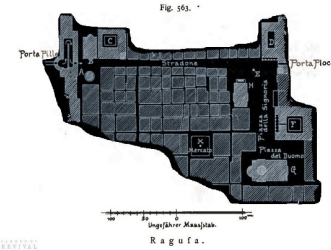

CC BY-SA: REVIVAL.indigignat - flickr.com

Often the environment of one or more structures forms a unit having its own functions and meanings. Thus it forms a kind of *background* of special centres and characteristic outline. E.g. The space between the houses of a city as a living space for pedestrians or as the space for a traffic network.

What complementary structures do we recognize? How can we create positive space and use its potential? How can we make the existing complementarities more effective? ...

related to: Contrast - Boundary - Good Form - Connectedness - Openness - The Other & Me - Context - Local Symmetry - Ambivalence - etc.

Good Form / Adaptation

S9



CC BY: healthy_pearley - flickr.com

Good forms often result from the adaptation to local forces and reflect these forces: in the form of the liquid drop, as a hanging chain or as the sail filled by the wind. Good forms are simple and lead us to understand the deep connectedness of form and function.

How do the forms of our systems implement their functions and reflect the actual forces? Could we improve the existing forms to better adapt to the situation? ...

related to: Variation - Forces - Form & Funktion - Boundary - Flexibility - Situation - Local Symmetry - Learning from Nature - etc.

Echo / Similarity

S10



CC BY-SA: Helmut Leithner

When looking in systems at the diversity of neighbouring forms we often find subtle similarities, like the family resemblance of relatives, similar silhouettes or rock formations of mountains, or familiar forms of traditional houses. This indicates that these individualities have grown from common materials and common processes or code.

What similarities can we see? What is the quality of the corresponding individualities? When creating something new - what are the echoes or similarities that we want to achieve? ...

related to: Alternating Repetition - Roughness / Individuality - Contrast - The New from the Existing - Proportions - Good Sequence - etc.

Roughness / Individuality / Diversity

S11



CC BY-SA: Ilwew - flickr.com

When something grows naturally it is rarely perfect. It deviates from ideals and becomes individual by small deviations, e.g. small variations in properties or traces of use or age. We can recognize individual things as unique. We primarily prefer and love those things and persons that feel unique and vivid.

How do our systems show diversity and individuality? How is the being-similar and being-different appreciated? How different may somebody or something be to still have a place in our system? ...

related to: Similarity - Local Symmetry - Field - Forces - Good Form / Adaptation - Whole - Quality of Living Systems / Lebendigkeit - etc.

Deep Interlock / Ambivalence

S12



CC BY: ... - flickr.com

Some parts of systems can be in such a deep interlock, that the local situation becomes highly ambivalent. Then the local centres can hardly be attributed to one or the other part. E.g. the orientation along a meandering river, or the intermingling of education and indoctrination. This interlock produces specific living spaces, opportunities, but also problems.

Are there parts of our systems that are interlocked? Does this have a positive or negative effect? Is the ambivalence to be strengthened or reduced? ...

related to: Boundary - Gradient - Contrast - Connectedness - Form & Funktion - Situation - Individually - Pro & Con - etc.

Simplicity / Inner Calm

S13



CC BY-SA Nyls - wikipedia

Simplicity often stands in contrast to a surrounding complexity of strong differentiation. Simple structures can be understood and handled more easily by their users. In a beginning simplicity comes naturally, at a later stage it often has to be worked out by removing the unnecessary.

Where is simplicity and complexity in our systems? Does this correspond to the needs of people? How would simplification or differentiation change the systems? What would be the effects? ...

related to: Simplest Step - Openness - Structure Preserving Transformation - Connectedness - Whole - Lebendigkeit - Local Symmetry - etc.

Gradient / Soft Transition

S14



CC BY-SA yvette.dong - flickr.com

A gradient means that system properties do not change abruptly but gradually. So there is a slow or soft transition, contrary to a sharp boundary or contrast. The gradient allows forces to balance in a relaxed way. A gradient produces a bandwidth of system conditions.

What transitions do we recognize in our systems? Are they abrupt or gradual? How would softer or sharper transitions change the quality of our systems? ...

related to: Boundary - Contrast - Variation - Adaptation - Simplicity - Forces - Proportions - Locale Symmetry - Field - etc.

Void / Open Structure

S15



CC BY-SA grodt7 - flickr.com

A void - a large empty space - provides a stage for things that are dynamic and new, for processes and change. Where there is nothing - a lot is possible. The void is connected to a feeling of openness and freedom: e. g. imagine the infinity of an ocean or the wideness of the blue sky.

What empty or free spaces do exist in our systems? Is everything filled with structures, everything planned? How much tolerance does exist to open for the new or different? ...

related to: Simplicity - Lebendigkeit - Spontaneous Space - Open Process - Gradient - Connectedness - Pattern - Flexibility - etc.

Changeability, Flexibility and Moveability

S16



CC BY-SA Ewert Bannas - flickr.com

An important property of living structures is their ability to change, to adapt, to move or be moved. This actually softens the very meaning of structure, to be persistent and resistant to change. But when as structure has this flexibility then variations and adaptations are possible all the time.

How rigid or flexible are the existing structures? Can they be adapted to varying forces and situations? Are the structures sufficiently stable and resilient? ...

related to: Structure - Process - Variation - Adaptation - Forces - Form & Function - Simplicity - Openness - etc.

Step by Step

P1



CC BY-SA moritz_schnitzler - flickr.com

Dynamic processes can be decomposed into sequences of separate steps. This makes sense because it is easier to identify, plan or work step by step than overall. You can decide pro or con a step, you can discuss it, get feedback, recognize it as success or failure, correct it, and learn from it.

What are the next steps possible? Which step should come next? Which steps were successful and which steps failed? Which steps had to be reversed? What can we learn from this? ...

related to: Process - Situation - Centre - Transformation - Simplicity - Reversibility - Rhythm - The New from the Existing - etc.

Healing Step

P2



CC BY-SA Callaemanoor - flickr.com

If a system has a serious problem it needs - like a human that suffers from a disease - a healing step, before one can work towards further development of the system. The healing step removes the problem, e. g. the weakness, and returns the system to old strength or even provides additional strength.

Do our systems have a special weakness that needs healing? Can the weakness be transformed into a strength? Do the systems and centres fill all their intended functions? ...

related to: Simplest Step - Form & Function - Reversibility - Problem & Solution - Transformation - Simplicity - etc.

Simplest Step

P3



CC BY-SA nuumo - flickr.com

In many situations our systems can be improved by very simple steps. We ignore this because our thinking is often too complicated. The complex high-image project seems more attractive as the near and natural. Therefore: always check for the simplest step to reach your goal.

What are the most pressing problems? What would be the simplest, fastest and most direct solutions? What is the simplest step? What are the reasons not to choose it? Are these reasons valid? ...

related to: Problem & Solution - Simplicity - Efficiency - Structure Preserving Transformation - Step by Step - Healing Step - Win All - etc.

Reversibility / Error Correction

P4

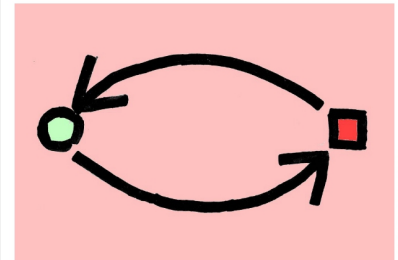

CC BY-SA Helmut Lehner

Errors burden a system the more the longer they remain in the system. Therefore the reversal of faulty transformations is very important. This implies the recognition of errors, so we must test continuously. Learning from our experience means: by trial and error correction. Also: we should prefer reversible steps because of their lower risks.

Are there errors in the system? Is there a culture of testing and of accepting errors as inevitable part of learning? Which steps are reversible and which are not? ...

related to: Step by Step - Lebendigkeit - Transformation - Pro & Con - Learning from Experience - Resonance Judgement - etc.

The New from the Existing

P5



CC BY: Small Roastin - flickr.com

It is very rare that something appears that is completely new. Most new things are combined, adapted or varied from existing things or parts. Sometimes a thing is even used unchanged for a new purpose or in a new way and so appears as innovation.

What potential parts, components or resources are available? How could they become effective in new ways? Can we imagine new useful combinations and variations? ...

related to: Step by Step - Adaptation - Flexibility - Simplicity - Connected Patterns - Variation - Connectedness - etc.

Structure Preserving Transformation

P6



CC BY: joweth-eu - flickr.com

Successful living processes often build on existing structures and improve them step by step. We can interpret this as *structure preserving transformation*, as a kind of *respect towards the existing*. Basically this also seems like a form of efficiency. The opposite is the complete removal of structures because they are faulty or superfluous.

Do we need the new and revolutionary? Or is it sufficient to adapt the existing structure, or to slightly change the organisation of a process? ...

related to: Simplicity - Step by Step - Connectedness - Efficient Use of Resources - Structure - etc.

Win All / Synergie

P7

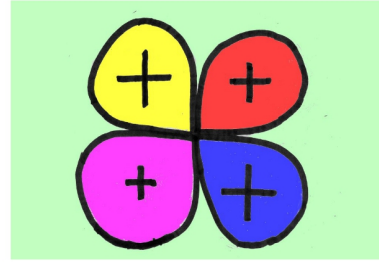

CC BY: SA - Helmut Lohrer

A transformation is more stable when the resulting advantages are fairly distributed. A big barrier that hinders change are people that fear possible disadvantages. Therefore a culture and praxis of fairness and solidarity, including tests and reversibility, is important.

Who are the persons affected directly and indirectly? What advantages and disadvantages do they have from the existing and the future system? Are the effects distributed fairly? ...

related to: Connectedness - Lebendigkeit - Situation - Design for People - Openness - Reversibility - Forces - Whole - etc.

Sequences Affect Results

P8

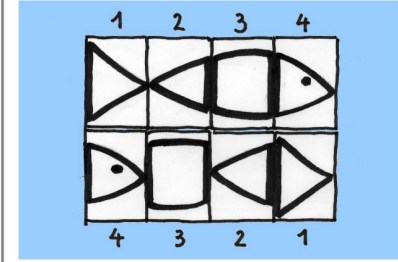

CC BY: SA - Helmut Lohrer

When the sequences of steps are changed the results typically change too, even if the steps are the same. Observed on a time scale, it looks like you have to find the correct point in time for some development, otherwise the step will not succeed. Logic and common sense can help, but sometimes only experience will give the successful sequences.

What are the next steps? Which sequence of these steps will give the best results? How will the results differ? Are there successful sequences from other knowledge sources available? ...

related to: Process - Transformation - Comparison Judgement - Alternative Pattern - Good Sequence - Example - Simplest Step - etc.

Pull of Participation / Open Process

P9



CC BY: yosek_R - flickr.com

If it is correct that the affected persons can understand a situation and make design decisions best, then it is fundamental to facilitate participation. This needs a culture of respect and knowledge sharing, of openness and tolerance, the attitude that it is important to empower people.

How can we make our systems more attractive? What opportunities do we offer for people to participate, to make the systems their own and to design their own life and environments? ...

related to: Design for People - Situation - Openness - Simplicity - Lebendigkeit - Forces - Spontaneous Space - Knowledge Sharing - etc.

Latent Centre / Hidden Potential

P10



CC BY: compugenmy - flickr.com

Latent centres are centres that do not exist but one can see that it is possible to create them. A transformation can create a centre, therefore the hidden potential for the centre is already existing in the situation. Often a weakness points to some potential. Existing centres and their structural properties can help in the search for potentials.

How do we describe the situation? What are the needs? What hidden potentials or latent centres do exist? What is possible? ...

related to: Centre - Field - Spontaneous Space - Transformation - Lebendigkeit - Sequence - Alternative - New from Existing - etc.

Efficient Resource Use

P11



CC BY: Thomas Fischer - flickr.com

Resources are typically limited and enforce optimizations, clear goals and decisions. The more efficient we handle resources the more problems can we solve. Nature often shows in an exemplary way how this can be done.

What are the existing and the necessary resources? How can we have the best effects from minimal use of resources? How can we reuse resources? How can we transform the waste from other processes to become a new valuable resource? ...

related to: Comparison Judgement - Pro & Con - Input & Output - Win All - Structure Preserving Transformation - Simplest Step - etc.

Good Sequence

P12



CC BY: ND - Michael Penne - flickr.com

Among the uncountable possible sequences are only a few that work and succeed in producing useful results. These good sequences are valuable and deserve special care and attention because they can be reused for free and should be in our focus of knowledge sharing.

What problems exist in ordering the steps of our development sequences? What experiences and sequences are available? How do we deal with the problem of sequences? ...

related to: Knowledge Sharing - Learning from History - Transformation - Efficient Resource Use - Pattern Story - Learning from Experience - etc.

Pattern

D1



Patterns are generic problem-solution-descriptions that can be adapted to situations and reused over and over without blind repetition - like the idea *bridge* is adapted to the landscapes and our needs. Patterns transform a system. They change centres or create new centres. Patterns are alternatives for action, an expression of culture and freedom.

Which patterns do we know and recognize? Which problems are solved? What are the effective forces? What alternatives do exist? What new problem are created? ...

related to: Variation - System - Context - Transformation - Pro & Con - Alternative Pattern - Pattern Language - etc.

Pattern Language

D2



Pattern languages are collections of patterns for designers and affected lay persons that can be used for certain design contexts. A pattern language should be reasonably complete, consistent, diverse and powerful. The goal of design is the living system, a design for people, not for profit.

Which pattern languages are in our focus? In what state of development are these pattern languages and their patterns? Who are the people responsible, the communities that work on them? ...

related to: Pattern - System - Design for People, not Profit - Variation - Adaptation - Context - Comparison Judgement - etc.

Problem & Solution / Meaning, Reasons

D3



A pattern describe a problem and the core of a solution in a way that both experts and lay persons can understand. Pattern descriptions support the discussion and decision making and so a sensible form of reuse. A pattern description also displays the forces, the reasoning and motivations, and so the meaning of the pattern.

Which systems, centre and patterns are in our focus? Which problems were the reasons for their creation? Why were the patterns chosen? How were the problems solved? ...

related to: System - Pattern - Pattern Language - Knowledge Sharing - Simplest Solution - Connectedness - Local Symmetry - etc.

Context / Design Perspective

D4



The context is the overall design situation in which the pattern and pattern language is meant to work. E. g. the pattern *pedestrian zone* thus belongs to the context *urban planning*. Often the perspective or the role of a designer is inseparable from the context. It is important to be clear about the context and the people and roles involved.

What are the design contexts, the people and roles involved? Which systems are to be developed? Who is to be supported by the pattern languages and patterns? ...

related to: System - Situation - Latent Potential - Pattern - Pattern Language - Lebendigkeit - Openness - Adaptation - Design for People - etc.

Sources

D5



A pattern is a short description of a problem and its solution. As this short description is typically not sufficient, references to the sources of further information - projects, experts, books and other publications - should be included. The references to the sources also fill the need to be fair towards the pioneers that have done the bulk of the work.

Where does the knowledge content of patterns and pattern languages come from? Who has done the work? How can the reader find out more about the pattern? ...

related to: Pattern - Pattern Language - Learning from History - Examples - Openness - Structure - Preserving Transformation - etc.

Examples

D6



A pattern description can look abstract and visionary, therefore examples are important. Some communities of practice even demand a number of real world examples, e. g. three examples, to be referenced before a pattern is accepted as real.

Where can we find the pattern in real world applications? What do the users report? Who is able to give detailed first hand experience? How do the examples differ? Do they show that the problem solution is generic? ...

related to: Pattern - Individuality - Simplest Step - Pattern Story - Sequence - Variation - Learning from History - etc.

Forces

D7



The concept *forces* contains all conditions and relations that influence a pattern and that are therefore important for deciding upon its use and its adaptation. This includes much more than just physical forces.

What are the forces that are important for our systems, their patterns and pattern languages? What are the resources, the inputs and outputs, the pros and cons, the indications and contraindications? ...

related to: System - Centre - Pattern - Pattern Language - Field - Good Form - Form & Function - Variation - etc.

Connected Pattern

D8

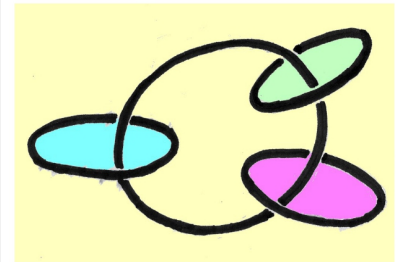

Patterns are in many ways connected to others patterns . Patterns solve problems and produce new problems - hopefully smaller - that are solved by further patterns. Patterns are fractal parts of larger patterns, and contain smaller patterns. Typically we are interested in patterns that are connected and put them in a pattern language for a certain context.

What are the patterns we focus? How are they spatially or functionally related? When we look at a pattern, which connected patterns should we also consider? ...

related to: Pattern - Pattern Language - Forces - Container Hierarchy - Form & Function - Pro & Con - Alternative Pattern - Context - etc.

Alternative Pattern

D9

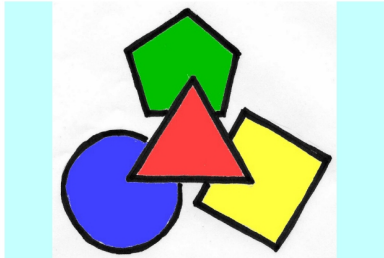

CC BY SA Helmut Lehner - flickr.com

Creative processes are open for the possibilities of many alternatives of design. There are alternatives e. g. to each form, pattern, action, description, artefact or example. Those who suggest that there is no alternative in a given situation seem to favour a rhetoric of power and control.

What alternatives do we see to the e. g. patterns, processes, centres, systems that we perceive? How can we act differently? How can we think differently to make more alternatives available? ...

related to: Artefact - The Other & Me - Spontaneous Space - Openness - New from Existing - Variation - Adaptation - etc.

Pro & Con

D10

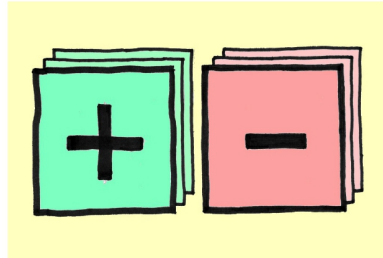

CC BY SA Helmut Lehner

Each change, transformation, use and variation of a pattern has its effects with respect to the personal needs and interests of the affected persons. If we think that more persons should participate in design decisions, then they should have access to all the arguments, to all pros and cons regarding the patterns and their variations.

What are the advantages of a pattern? What are the disadvantages and side effects? How do the pros and cons look differently from the various perspectives? ...

related to: Situation - Individuality - Adaptation - Variation - Lebendigkeit - Comparison - Judgement - Win All - Reversibility - etc.

Inputs & Outputs

D11



CC BY SA Helmut Lehner

When looking at patterns and pattern languages the resources play an important role, especially as inputs and outputs. You need e. g. energy, materials, space, human time and knowledge. The positive results of patterns can be accompanied by unwanted wastes and side effects.

What are the resources involved? What amounts of resources are needed and produced? Does this resource production and consumption lead into new problems? What are the alternatives? ...

related to: Pattern - Forces - Pro & Con - Pattern Language - Connectedness - Step by Step - Simplest Step - etc.

Pattern Story

D12



CC BY SA Helmut Lehner

Stories are a very efficient way to communicate experiences and knowledge. Therefore patterns and pattern languages shouldn't be pure factual items but also pieces of literature that activate feelings, allow for identification, and show aesthetic and dramatic qualities as well.

What stories, what human fates and mental adventures are behind the abstract patterns? How does this let us understand sequences and variations? What stories can you tell? ...

related to: Knowledge Sharing - Lebendigkeit - Pattern - Pattern Language - Context - Good Form - Individuality - The Other & Me - etc.

Variation

D13



CC BY SA nobyphay - flickr.com

When a generic pattern is meant to be reused a million times without identical repetition, then there must be variations of multiple properties so that countless combinations are possible. Therefore it makes sense to describe the possibilities of variation sufficiently.

What are the variable properties of the patterns? Which variations are possible? How does the quality of the patterns in the situations change depending on the variations? ...

related to: Pattern - Situation - Individuality - Alternative Pattern - Similarity - Lebendigkeit - Pattern Language - Resonance - Judgement - etc.

Learning from Experience

A1



CC BY SA woodbywindworks - flickr.com

The basis of life - as pictured by the natural evolution - is individual action with trial and error correction, the learning from experience. This is connected to creativity and spontaneity. This way the new comes into the world.

How strong is our own individual experimenting? What is special with us and our situation? In which relation is our individual learning and the learning from nature and the learning from history? How strong do we value our own impulses and visions? ...

related to: Process - Step by Step - Individuality - Situation - The Other & Me - Eyes of Resonance - Latent Potential - Pattern - etc.

Meaning of Life / Contribution to Life

A2



CC BY SA Shelan Munder - flickr.com

All parts of the living process that includes nature and human cultures have a common „characteristic vector of life“. Single aspects like creativity, spontaneity and of communication point towards a general phenomenon of life, that has a calling for each and every one of us.

What do our systems contribute to life? How do we, as individuals, contribute to life? How do we reach the joy of life, the identification with life and the love of life? ...

related to: Process - Situation - Design for People - Step by Step - Field - Win All - Reversibility - Connectedness - etc.

Learning from Nature

A3



CC BY ND dno_Ma_you - flickr.com

Nature is the best teacher: e. g. by its diversity of forms, its efficiency, and its successful processes. To think humankind and its cultures separate from nature would violate all logic and would create a misrepresentation of the human dependency on nature as part of nature.

What can we learn from nature for our systems? How are our systems similar to natural systems? How do they differ? Which structures and processes could provide models or clues? ...

related to: Openness - Connectedness - Lebendigkeit - Simplicity - Reversibility - Learning from History - etc.

Artefacts!

A4



CC BY: Bemb - flickr.com

The material and immaterial items of human culture are essentially artefacts, i. e. they are the contingent results of creative processes that could have led to other possible different results. Therefore: e. g. institutions, things, words, and habits are not God-given but have resulted from a mixture including rationality and historic contingency.

What are the patterns in our focus? What problems did they solve? Do they still solve them? What are the possible alternatives? Are we sufficiently aware of the free space we have? ...

related to: Problem & Solution - Lebendigkeit - Alternative Pattern - Learning from History - Comparison Judgement - Form & Function - etc.

Learning from History / Learning from Others

A5



CC BY: Fiona Bradley - flickr.com

History offers a rich treasure chest of experiences and problem solutions but access is not effortless. Sometime the situation seems totally different, so it seems impossible to transfer the experience. But it is said: those who do not learn from history are predestined to repeat it.

What can we learn from history for our systems? What sources and predecessors are available? How can we efficiently use the experiences from others and make our experiences available for others? ...

related to: Pattern - Pattern Language - Learning from Experience - Learning from Nature - Examples - Variation - Knowledge Sharing - etc.

Design for People, Not for Profit!

A6



CC BY: Howard County Library System - flickr.com

An early Alexandrian insight is that the best designs come from putting the affected people and life itself - Lebendigkeit, the quality of living systems - into the centre of the design process. This is the very starting point for everything: for the other&me relationship, for participation and knowledge sharing by using patterns and pattern languages.

What are our relationships to life and design? What are our goals? Whom do we want to help and in which ways? ...

related to: Lebendigkeit - Connectedness - New from Existing - The Other & Me - Openness - Knowledge Sharing - etc.

Comparison Judgement / Eyes of Resonance

A7

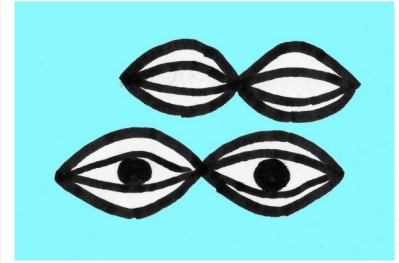

CC BY: SA: Helmut Lehner

If you want to increase Lebendigkeit - the quality of living systems - you need a method to make the corresponding judgements. The side-by-side comparison of two alternatives is the easiest way to do this, if the questions are tuned to that purpose.

Which alternative resonates more with you? Which alternative is more lebendig, leads to a system that has more vitality? Which alternative corresponds more to your self, your whole being, to what you are and to what you want to be? ...

related to: Lebendigkeit - Design for People - Process - The Other & Me - Connectedness - System - Participation - etc.

The Right Measure

A8



CC BY: dekk, seahaler - flickr.com

There is no thing that is good in every situation. Paracelsus said: the dose makes a substance work as poison or medicine. The Greek philosophers searched for the right measure in everything. Alexander shows the contrariness of the ideal properties of living structures. No principle can be applied blindly without risking failure.

Which properties exist in our systems in what quality? Is this too little or too much? How do forces, ideals, rules, structures or principles contradict each other? ...

related to: Situation - Comparison Judgement - Ambivalence - Proportion - Symmetry - Variation - Adaptation - Form & Function - etc.

Knowledge Sharing

A9



CC BY: Don Tapscott - flickr.com

Many issues are beyond the personal sphere and power and therefore need actions in community. The common goals are living systems that embody sustainability and resilience. The basis for informed decisions and successful actions must be shared knowledge of sufficient quality.

What are the systems in our focus and the affected people? How can they all communicate and collaborate to find knowledge and share it? How can the necessary communities be created? ...

related to: The Other & Me - Pattern Language - Learning from Experience - Pattern - Situation - Comparison Judgement - Lebendigkeit - System - etc.

The Other & Me / Living Relationship

A10

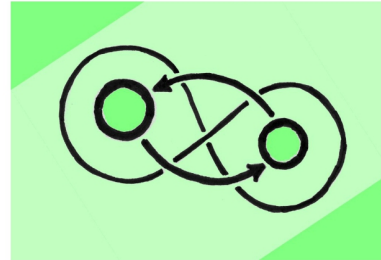

CC BY: SA: Helmut Lehner - flickr.com

The me, I or self is not an isolated subject but interacts from the first moment with the other: persons, things, with the totality of the world. The self as a system is inseparable from the other as environment. Self development is connected to the development of the other. This works best in a living relationship that embodies attention, care for development, sharing of joy - the essence of love.

Which kinds of other do we face? What does this mean for us? Where do we draw our boundaries? How do we feel connected? ...

related to: Contrast - Lebendigkeit - Boundary - Connectedness - Individuality - Openness - Learning from Experience - Win All - etc.

The Missing Concept / Completion & Correction

A11



CC BY: Steffen Bandy - flickr.com

Alexandrian thinking - and this Glas Bead Game card deck - is meant to be open, not closed. Openness bears on all levels: structures and processes, concepts and attitudes, patterns and pattern languages. If you miss a card in this stack: design it and add it to the deck. This deck is a start.

Which essential thoughts are missing? Which concepts should be complemented? What is wrong and should be corrected? What wordings should be reworked because they can be misunderstood? ...

related to: Void - Openness - Lebendigkeit - Alternative Pattern - Adaptation - Variation - Learning from Experience - etc.

Alexander's **Patterns** (vs. Aristotle's Categories) to View the World

Aristotle: The world as genealogical trees of species;
difference = a property for the distinction between two species

2300 years of thinking
 "objects and categories"
 (clearly delimited boxes)
 (separation is the goal)

Alexander: The world as networks of patterns
connections = relationships for understanding a system

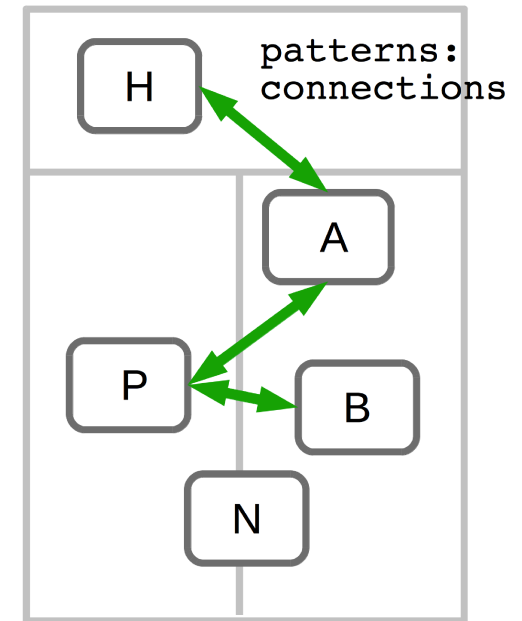
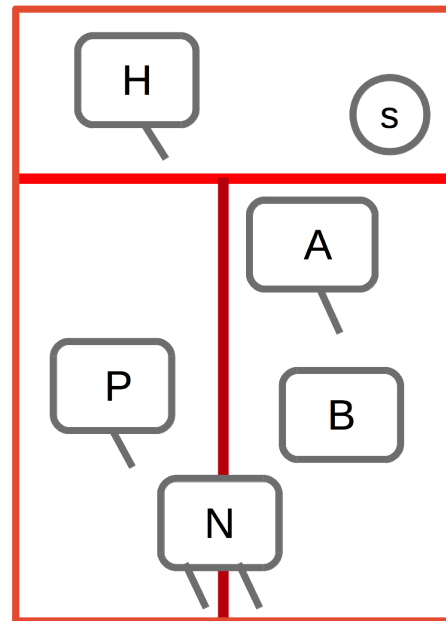
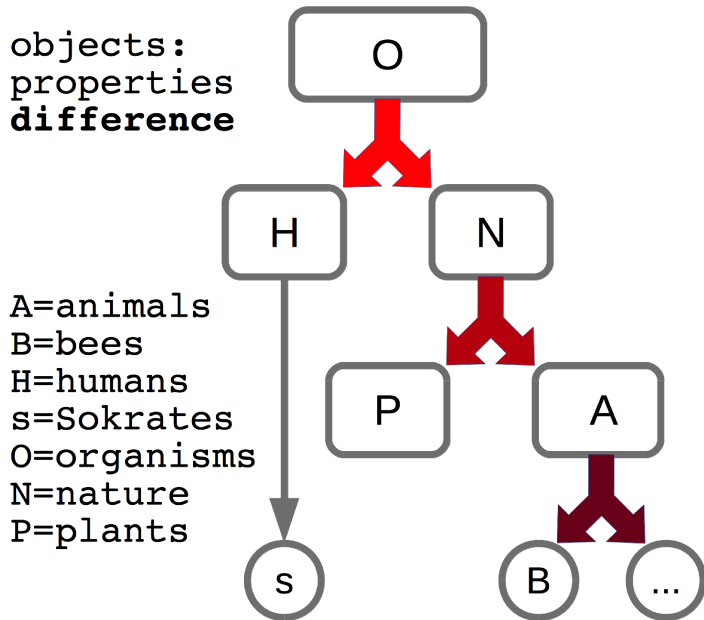

Categorical knowledge:
 Socrates is a human.
 All humans are mortal.
 Logic: Socrates is mortal.

Systemic knowledge: „If the bee disappeared off the surface of the globe then man would only have four years of life left. No more bees, no more pollination, no more plants, no more animals, no more man.“
 – attributed to Albert Einstein

Descartes vs. Alexander (Enlightenment vs. Enlivenment)

	René Descartes	Christopher Alexander
Method	Analysis(+Synthesis)	Analysis+Synthesis
Model	Machine, functioning	Organism, evolving
Concept of Order	Category	Pattern
Guiding Aspekt	Property-Difference	Function-Connection
Working Hypothesis	Causality	Contingency
Goal	Prognosis of Processes	Support of Processes
Logic	Aristotelian Difference-Logic	Alexandrian Connectedness-Logic
Human Being	Biological Robot	Creative Designer
Science	Natural Science	Lebendigkeit Science